

PACKAGE DIMENSIONS

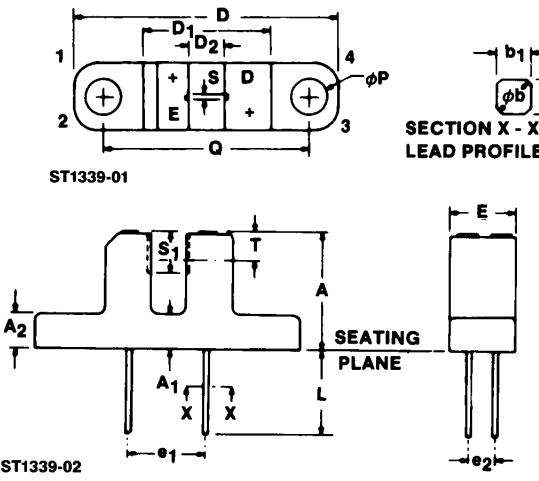

SYMBOL	MILLIMETERS		INCHES		NOTES
	MIN.	MAX.	MIN.	MAX.	
A	10.7	11.0	.422	.433	
A ₁	3.0	3.2	.119	.125	
A ₂	3.0	3.2	.119	.125	
@b	.600	.750	.024	.030	2
b ₁	.50 NOM.		.020 NOM.		2
D	24.3	24.7	.957	.972	
D ₁	11.6	12.0	.457	.472	
D ₂	3.0	3.3	.119	.129	
e ₁	6.9	7.5	.272	.295	
e ₂	2.3	2.8	.091	.110	
E	6.15	6.35	.243	.249	
L	8.00		.315		
@p	3.2	3.4	.126	.133	
Q	18.9	19.2	.745	.755	
S	.85	1.0	.034	.039	
S ₁	3.45	3.75	.136	.147	
T	2.6 NOM.		.103 NOM.		3

- NOTES:
1. INCH DIMENSIONS ARE DERIVED FROM MILLIMETERS.
 2. FOUR LEADS. LEAD CROSS SECTION IS CONTROLLED BETWEEN 1.27mm (.050") FROM SEATING PLANE AND THE END OF THE LEADS.
 3. THE SENSING AREA IS DEFINED BY THE "S" DIMENSION AND BY DIMENSION "T" ±0.75mm (±.030 INCH).

PACKAGE OUTLINE

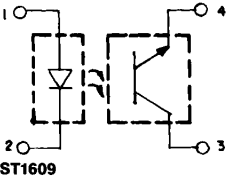

DESCRIPTION

The H21A Slotted Optical Switch is a gallium arsenide light emitting diode coupled to a silicon phototransistor in a plastic housing. The packaging system is designed to optimize the mechanical resolution, coupling efficiency, ambient light rejection, cost and reliability. The gap in the housing provides a means of interrupting the signal with an opaque material, switching the output from an "ON" to an "OFF" state.

FEATURES

- Opaque housing
- Low cost
- .035" apertures
- High I_{C(ON)}



SLOTTED OPTICAL SWITCH

ABSOLUTE MAXIMUM RATINGS ($T_A = 25^\circ\text{C}$ Unless Otherwise Specified)	
Storage Temperature	-55°C to $+100^\circ\text{C}$
Operating Temperature	-55°C to $+100^\circ\text{C}$
Soldering:	
Lead Temperature (Iron)	240°C for 5 sec. ^(3,4,5)
Lead Temperature (Flow)	260°C for 10 sec. ^(3,4)
INPUT DIODE	
Continuous Forward Current	60 mA
Reverse Voltage	6.0 Volts
Power Dissipation	100 mW ⁽¹⁾
OUTPUT TRANSISTOR	
Collector-Emitter Voltage	30 Volts
Emitter-Collector Voltage	6 Volts
Power Dissipation	150 mW ⁽²⁾

ELECTRICAL CHARACTERISTICS ($T_A = 25^\circ\text{C}$ Unless Otherwise Specified) (All measurements made under pulse conditions.)						
PARAMETER	SYMBOL	MIN.	TYP.	MAX.	UNITS	TEST CONDITIONS
INPUT DIODE						
Forward Voltage	V_F	—	1.7	—	V	$I_F = 60\text{ mA}$
Reverse Breakdown Voltage	V_R	6.0	—	—	V	$I_R = 10\ \mu\text{A}$
Reverse Leakage Current	I_R	—	—	1.0	μA	$V_R = 3\text{ V}$
OUTPUT TRANSISTOR						
Emitter-Collector Breakdown	BV_{ECO}	6.0	—	—	V	$I_E = 100\ \mu\text{A}$, $E_e = 0$
Collector-Emitter Breakdown	BV_{CEO}	30	—	—	V	$I_C = 1\text{ mA}$, $E_e = 0$
Collector-Emitter Leakage	I_{CEO}	—	—	100	nA	$V_{CE} = 25\text{ V}$, $E_e = 0$
COUPLED						
On-State Collector Current	$I_{C(ON)}$	—	See page 3.	—	mA	
Saturation Voltage	$V_{CE(SAT)}$	—	See page 3.	—	V	
Turn-On Time	t_{on}	—	See page 3.	—	μS	
Turn-Off Time	t_{off}	—	See page 3.	—	μS	

NOTES
<ol style="list-style-type: none"> 1. Derate power dissipation linearly $1.33\text{ mW}/^\circ\text{C}$ above 25°C. 2. Derate power dissipation linearly $2.00\text{ mW}/^\circ\text{C}$ above 25°C. 3. RMA flux is recommended. 4. Methanol or Isopropyl alcohols are recommended as cleaning agents. 5. Soldering iron tip $\frac{1}{16}$" (1.6 mm) from housing.



SLOTTED OPTICAL SWITCH

$I_{C(ON)}$, $V_{CE(SAT)}$, t_{on}, AND t_{off}						
PARAMETER	SYMBOL	MIN.	TYP.	MAX.	UNITS	TEST CONDITIONS
ON-STATE COLLECTOR CURRENT						
H21A1	$I_{C(ON)}$	0.15	—	—	mA	$I_F = 5mA, V_{CE} = 5V$
H21A2	$I_{C(ON)}$	0.30	—	—	mA	$I_F = 5mA, V_{CE} = 5V$
H21A3	$I_{C(ON)}$	0.60	—	—	mA	$I_F = 5mA, V_{CE} = 5V$
H21A1	$I_{C(ON)}$	1.0	—	—	mA	$I_F = 20mA, V_{CE} = 5V$
H21A2	$I_{C(ON)}$	2.0	—	—	mA	$I_F = 20mA, V_{CE} = 5V$
H21A3	$I_{C(ON)}$	4.0	—	—	mA	$I_F = 20mA, V_{CE} = 5V$
H21A1	$I_{C(ON)}$	1.9	—	—	mA	$I_F = 30mA, V_{CE} = 5V$
H21A2	$I_{C(ON)}$	3.0	—	—	mA	$I_F = 30mA, V_{CE} = 5V$
H21A3	$I_{C(ON)}$	5.5	—	—	mA	$I_F = 30mA, V_{CE} = 5V$
SATURATION VOLTAGE						
H21A2	$V_{CE(SAT)}$	—	—	0.40	V	$I_F = 20mA, I_C = 1.8mA$
H21A3	$V_{CE(SAT)}$	—	—	0.40	V	$I_F = 20mA, I_C = 1.8mA$
H21A1	$V_{CE(SAT)}$	—	—	0.40	V	$I_F = 30mA, I_C = 1.8mA$
Turn-On Time	t_{on}	—	8	—	μS	$V_{CC} = 5V, I_F = 30mA, R_L = 2.5K\Omega$
Turn-Off Time	t_{off}	—	50	—	μS	$V_{CC} = 5V, I_F = 30mA, R_L = 2.5K\Omega$

TYPICAL CHARACTERISTICS

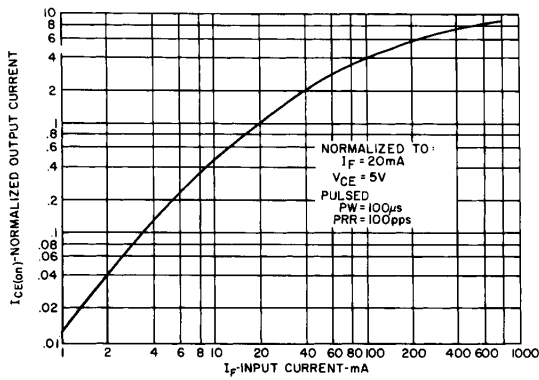

Fig. 1. Output Current vs. Input Current ST1129-11

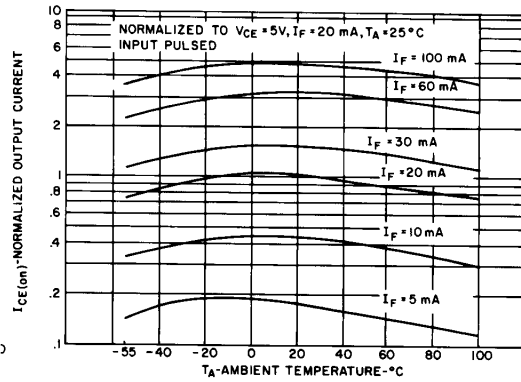

Fig. 2. Output Current vs. Temperature ST1134-11

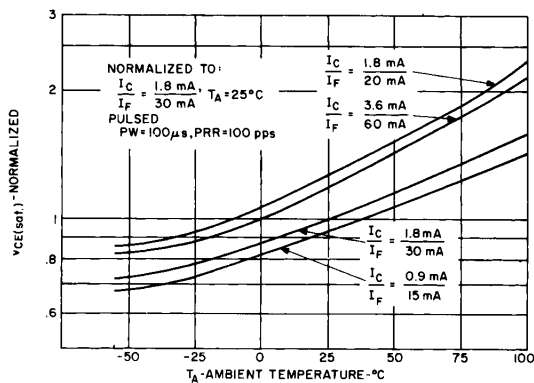

Fig. 3. $V_{CE(SAT)}$ vs. Temperature ST1130-11

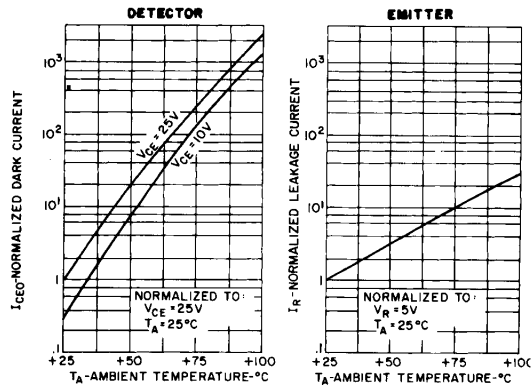

Fig. 4. Leakage Currents vs. Temperature ST1133-11

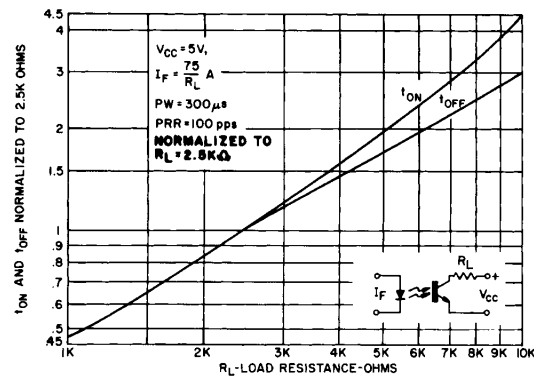

Fig. 5. Switching Speed vs. R_L ST1131-11

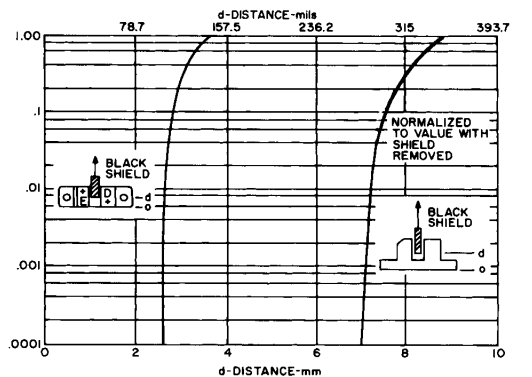

Fig. 6. Output Current vs. Distance ST1132-11