

**LAMPIRAN A**  
**DATA ANTROPOMETRI TUBUH**

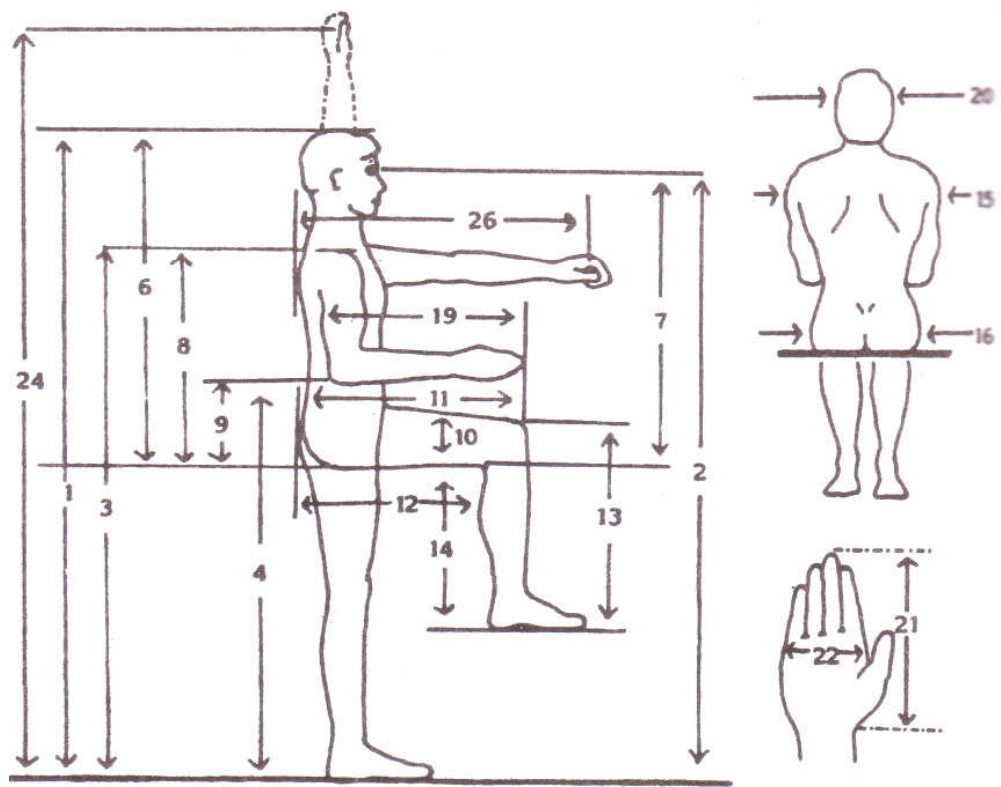

DIMENSI TUBUH	PRIA				WANITA			
	5%	X	95%	S.D	5%	X	95%	S.D
1. Tinggi Tubuh Posisi berdiri Tegak	1.532	1.632	1.732	61	1.464	1.563	1.662	60
2. Tinggi Mata	1.425	1.520	1.615	58	1.350	1.446	1.542	58
3. Tinggi Siku	1.367	1.468	1.569	55	1.284	1.382	1.481	54
4. Tinggi Bahu	947	1.043	1.139	49	884	977	1.069	48
5. Tinggi Pergangan Tangan (Karpale) pada Posisi Tangan lurus kebawah	685	718	752	38	646	700	771	35
6. Tinggi Badan pada Posisi Duduk	869	864	819	33	775	844	893	36
7. Tinggi Mata pada Posisi Duduk	694	745	804	33	666	721	776	33
8. Tinggi Bahu pada Posisi Duduk	523	572	621	30	501	550	599	30
9. Tinggi siku pada Posisi Duduk	481	531	582	31	475	529	583	33
10. Balok Paha	117	140	163	14	115	140	165	15
11. Jarak dari Pusat ke Lengan	500	548	596	27	488	537	585	28
12. Jarak dari Lengan ke Pusat (kapasitas) ke Depan	485	488	490	27	484	487	490	28
13. Tinggi Lengan	440	485	541	33	432	472	518	37
14. Tinggi Lengan ke Pusat (kapasitas)	361	403	445	26	357	392	428	28
15. Lengan ke Pusat (kapasitas)	383	421	456	26	343	385	428	28
16. Lengan ke Depan	391	431	471	24	382	425	468	28
17. Balok Bahu	174	222	269	23	172	228	276	26
18. Balok Pusat (kapasitas)	174	222	269	23	172	224	267	24
19. Jarak dari Bahu ke Lengan ke Depan	465	485	473	31	374	402	437	34
20. Lengan ke Depan	140	159	160	6	126	146	167	7
21. Panjang Tangan	161	176	191	9	154	166	188	9
22. Lengan Tangan	71	79	87	5	64	71	79	4
23. Jarak Bahu ke Ujung jari Tangan Kiri ke Kanan	1.580	1.685	1.683	37	1.400	1.520	1.640	28
24. Tinggi Pergangan Tangan (jari) pada Posisi Tangan Terentang ke Atas & Bawah Tegak	1.705	1.943	2.051	78	1.718	1.841	1.960	78
25. Tinggi Pergangan Tangan (jari) pada Posisi Tangan Terentang ke Atas & Bawah	1.045	1.169	1.273	46	945	1.050	1.115	32
26. Jarak Pergangan Tangan (jari) ke Pergangan pada Posisi Tangan ke Depan (horizontal)	849	908	967	37	610	661	712	31

**LAMPIRAN B**  
**DATA ANTROPOMETRI**  
**TELAPAK TANGAN**

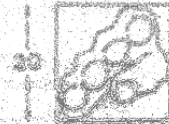
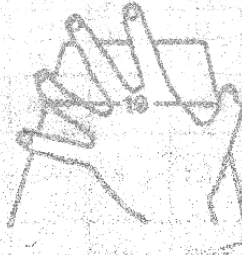
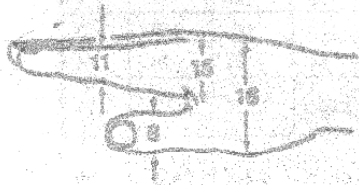
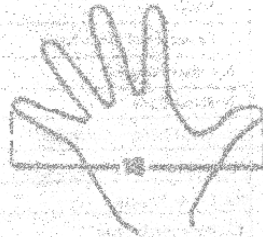
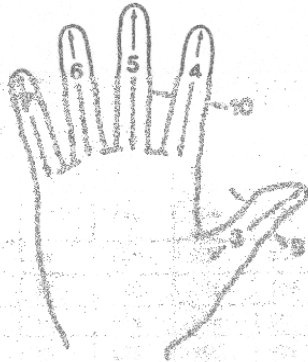
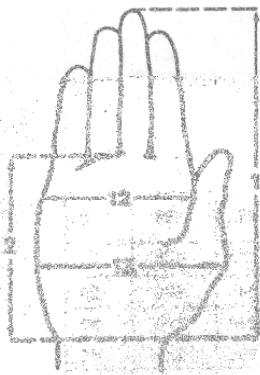

D I M E N S I	P R I A				W A N I T A			
	5th	50th	95th	S.D.	5th	50th	95th	S.D.
1. Panjang Tangan	163	176	189	8	155	168	181	8
2. Panjang Telapak Tangan	92	100	108	5	87	94	101	4
3. Panjang Ibu Jari	45	48	51	2	42	45	48	2
4. Panjang Jari Telunjuk	62	67	72	3	60	65	70	3
5. Panjang Jari Tengah	70	77	84	4	69	74	79	3
6. Panjang Jari Manis	62	67	72	3	58	64	69	3
7. Panjang Jari Kelingking	48	51	54	2	45	48	51	2
8. Lebar Ibu Jari (IPJ)	19	21	23	1	16	18	20	1
9. Tebal Ibu Jari (IPJ)	19	21	23	1	15	17	19	1
10. Lebar Jari Telunjuk (PIPJ)	18	20	22	1	15	17	19	1
11. Tebal Jari Telunjuk (PIPJ)	15	18	20	1	13	15	17	1
12. Lebar Telapak Tangan (Metacarpal)	74	81	88	4	68	73	78	3
13. Lebar Telapak Tangan (sampai Ibu Jari)	88	98	108	6	82	89	96	4
14. Lebar Telapak Tangan (Minimum)	68	75	82	4	64	69	74	3
15. Tebal Telapak Tangan (Metacarpal)	28	31	34	2	23	27	29	1
16. Tebal Telapak Tangan (sampai Ibu Jari)	41	46	47	2	41	44	47	2
17. Diameter Genggam (maksimum)	45	48	51	2	43	46	49	2
18. Lebar Maksimum (Ibu Jari ke Jari Kelingking)	177	192	206	9	169	184	199	9
19. Lebar Fungsional Maksimum (Ibu Jari ke Jari Kelingking)	122	132	142	6	113	123	134	6
20. Segi Empat Minimum yang dapat diawasi Telapak Tangan	57	62	67	3	51	56	61	3

**Catatan :**

IPJ = Interphalangeal Joint (Sambungan antar ruas tulang jari).

PIPJ = Proximal Interphalangeal Joint (Sambungan antar ruas tulang jari ke arah mendekati tubuh).

**LAMPIRAN C**  
**DATA ANTROPOMETRI KEPALA**

DIMENSI	PRIA				WANITA			
	5%	x	95%	S.D	5%	x	95%	S.D
1. Panjang kepala	166	176	186	6	158	168	178	6
2. Lebar kepala	132	140	148	5	121	129	137	5
3. Diameter maksimum ke dagu	217	230	243	8	198	209	221	7
4. Daggu ke puncak kepala	192	203	215	7	185	196	208	7
5. Telinga kepuncak kepala	70	77	84	4	69	74	79	3
6. Telinga ke belakang kepala	62	67	72	3	59	64	69	3
7. Antara dua telinga	48	51	54	2	45	48	51	2
8. Mata ke puncak kepala	21	21	23	1	16	18	20	1
9. Mata ke belakang kepala	18	21	23	1	15	17	19	1
10. Antara dua pupil mata	18	20	22	1	15	17	19	1
11. Hidung ke puncak kepala	16	18	20	1	13	15	17	1
12. Hidung ke belakang kepala	74	81	88	4	68	73	78	3
13. Mulut ke puncak kepala	88	98	108	6	82	89	96	4
14. Lebar mulut	68	75	82	4	64	59	74	3

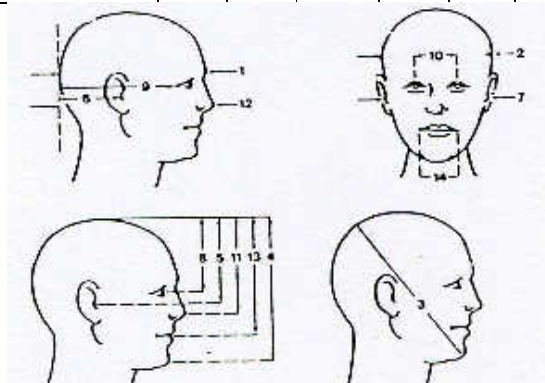



**LAMPIRAN D**  
**DATA ANTROPOMETRI KAKI**

Antropometri Kaki Orang Indonesia yang didapat dari interpolasi data Dempster (1955), Reynolds (1978), dan Nurmianto (1991).

Dimana : Panjang telapak kaki = 15,2% tinggi badan pria dan 14,7% tinggi badan wanita. Dari pendekatan tersebut diusahakan interpolasi antropometri dengan koefisien variansi yang sesuai.

DIMENSI	PRIA				WANITA			
	5th	50th	95th	S.D.	5th	50th	95th	S.D.
1. Panjang Telapak Kaki	230	248	266	11	212	230	248	11
2. Panjang Telapak Lengan Kaki	165	178	191	8	158	171	184	8
3. Panjang Kaki sampai Jari Kelingking	186	201	216	9	178	191	204	8
4. Lebar Kaki	82	89	96	4	81	88	95	4
5. Lebar Tangkai Kaki	61	66	71	3	49	54	59	3
6. Tinggi Mata Kaki	61	66	71	3	59	64	69	3
7. Tinggi Bagian Tengah Telapak Kaki	68	75	82	4	64	69	74	3
8. Jarak Horisontal Tangkai Mata Kaki	49	52	55	2	46	49	52	2

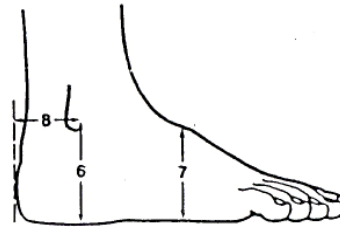
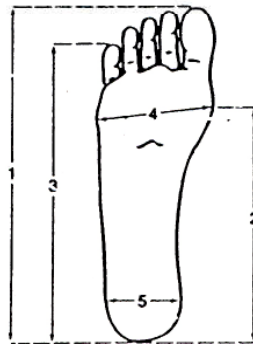

**LAMPIRAN E**  
**GAMBAR – GAMBAR**  
**PERANCANGAN**

**KURSI STUDIO**



**LEMARI PENYIMPANAN PERALATAN**



**KURSI STAFF DAN PENGUNJUNG**



**MEJA STAFF**



## MEJA RIAS



## KAMAR GANTI



## **TEMPAT GANTUNGAN BAJU**

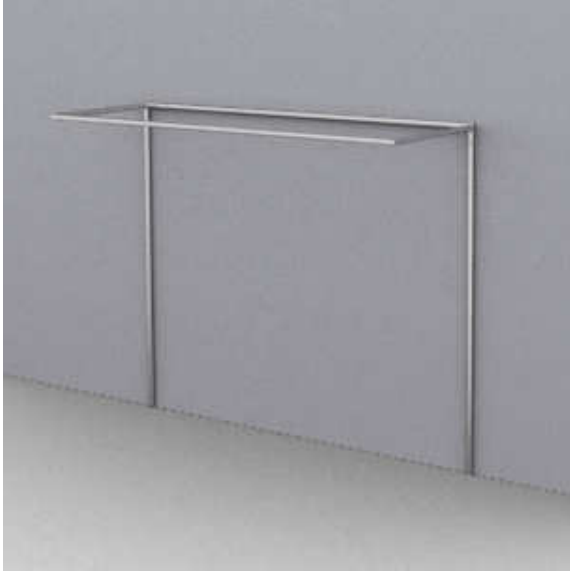







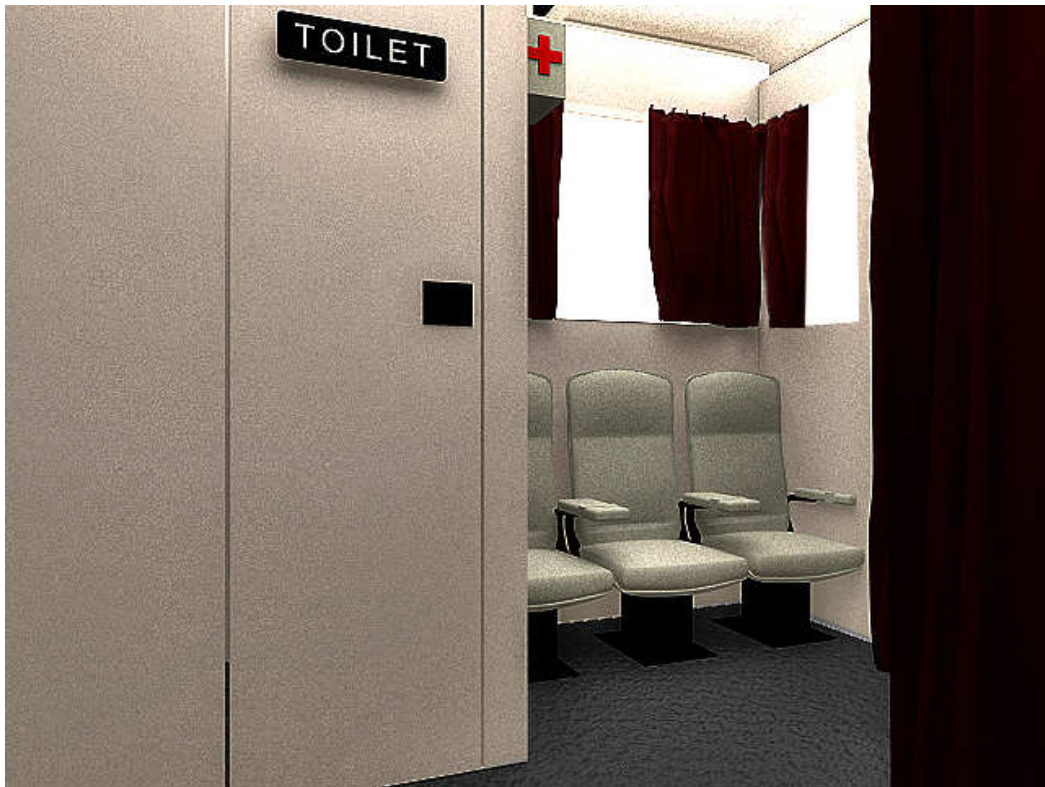

TAMPAK ATAS

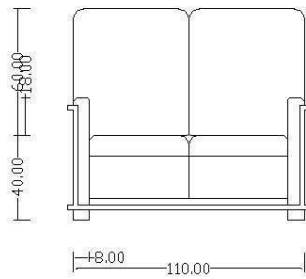
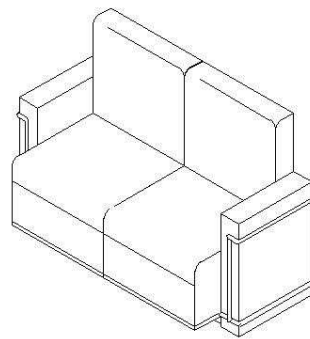
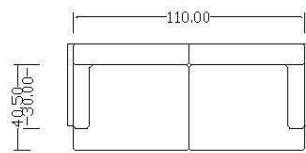

TAMPAK DEPAN

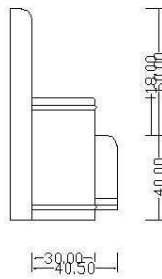

TAMPAK SAMPING

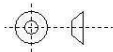

SKALA : 1:20  
SATUAN : cm  
TANGGAL : 05-03-08

DIGAMBAR:  
DILIHAT:

Kursi Studio Alternatif 1

PROYEKSI AMERIKA

A4

TAMPAK ATAS

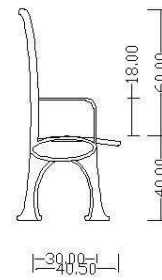
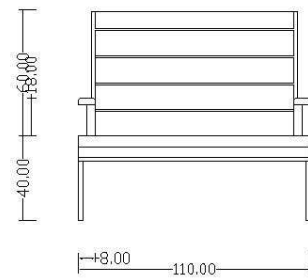
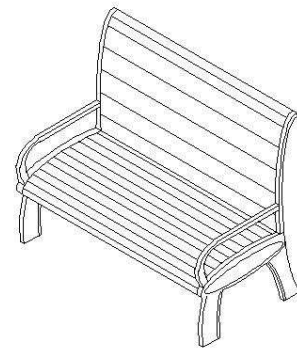
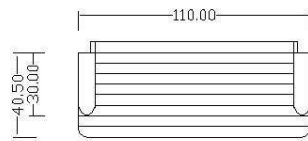

TAMPAK DEPAN

TAMPAK SAMPING

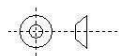

SKALA : 1:20  
SATUAN : cm  
TANGGAL : 05-03-08

DIGAMBAR:  
DILIHAT:

Kursi Studio Alternatif 2

PROYEKSI AMERIKA

A4

TAMPAK ATAS

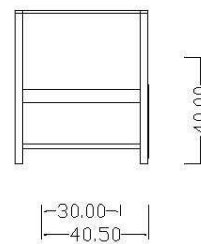
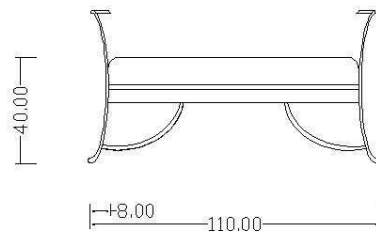
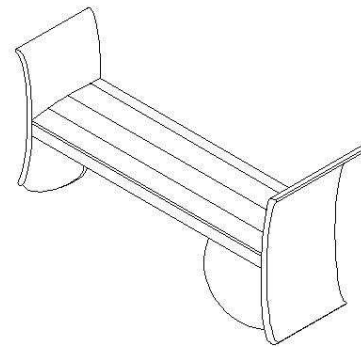
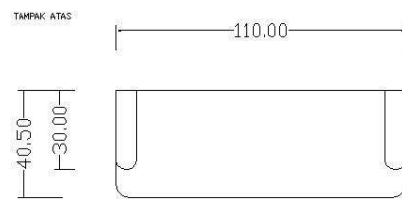

TAMPAK DEPAN

TAMPAK SAMPING

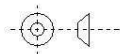

SKALA : 1:20  
 SATUAN : cm  
 TANGGAL : 05-03-08

DIGAMBAR:  
 DILIHAT:

Kursi Studio Alternatif 3

PROYEKSI AMERIKA

A4

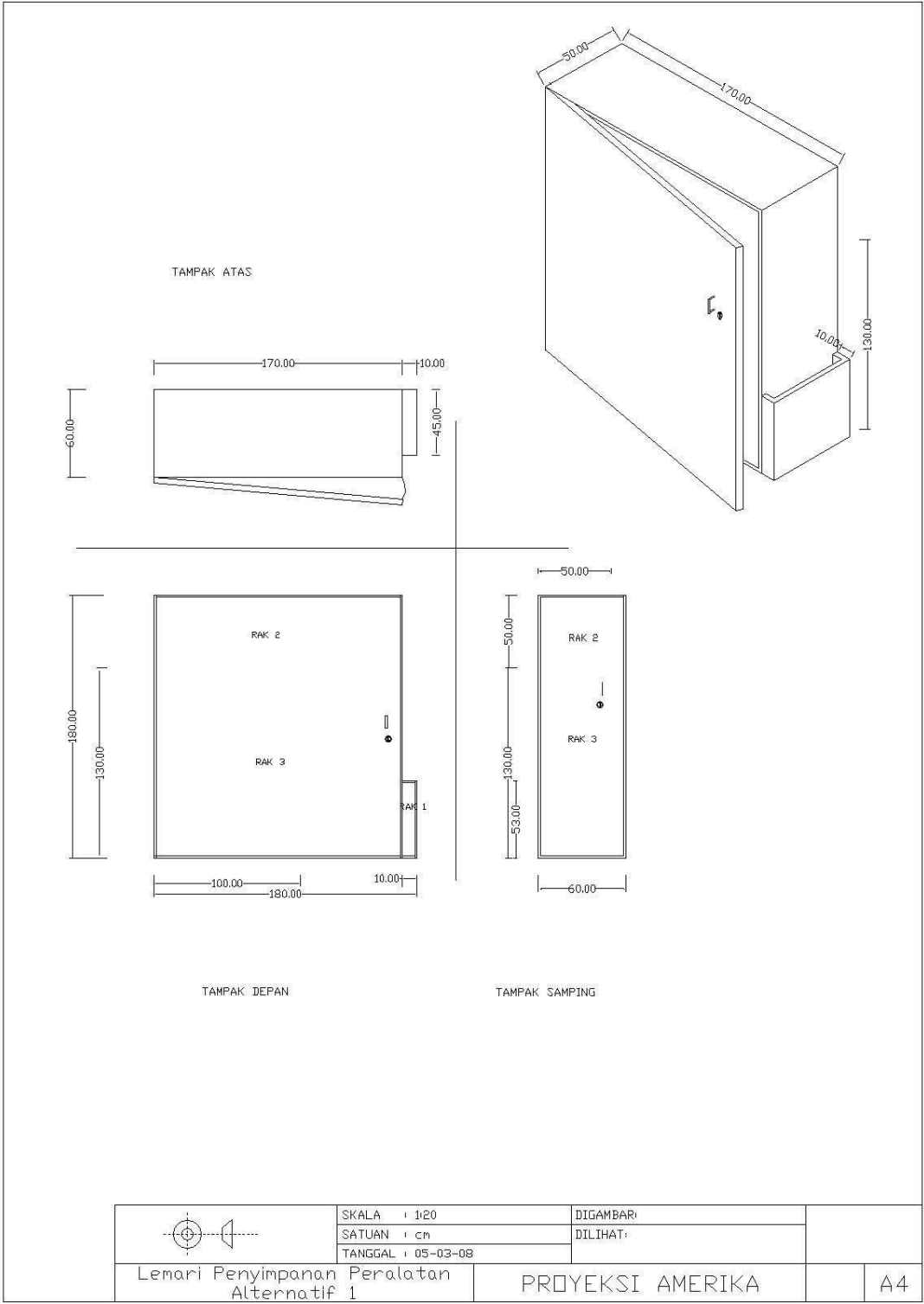

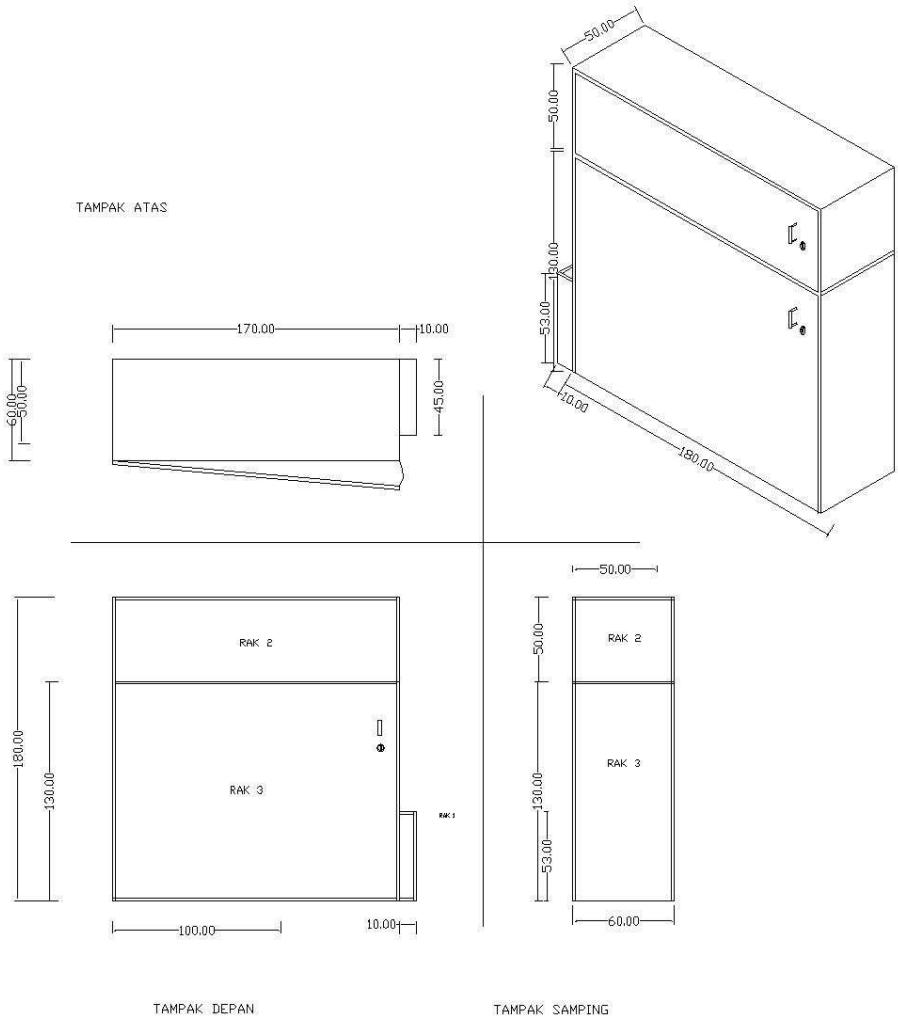

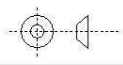
	SKALA : 1:20	DIGAMBAR:	
	SATUAN : cm	DILIHAT:	
	TANGGAL : 05-03-08		
Lemari Penyimpanan Peralatan Alternatif 2		PROYEKSI AMERIKA	A4

TAMPAK ATAS

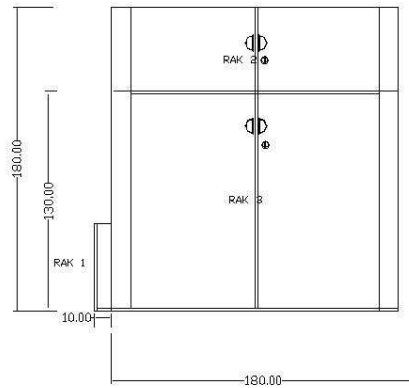
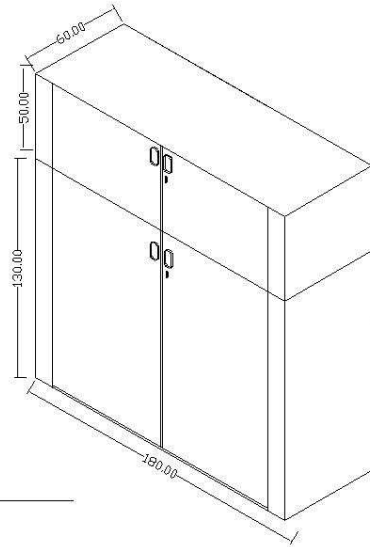
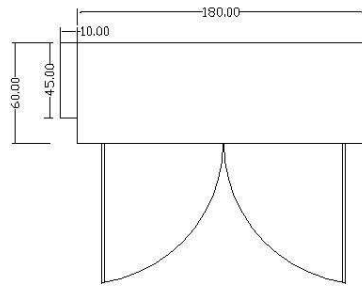

TAMPAK DEPAN

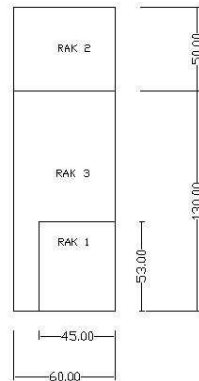

TAMPAK SAMPING

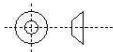

SKALA : 1:20  
 SATUAN : cm  
 TANGGAL : 05-03-08

DIGAMBAR:  
 DILIHAT:

Lemari Penyimpanan Peralatan  
 Alternatif 3

PROYEKSI AMERIKA

A4



TAMPAK ATAS

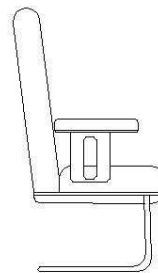
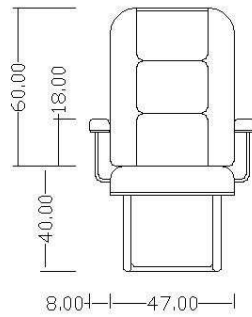
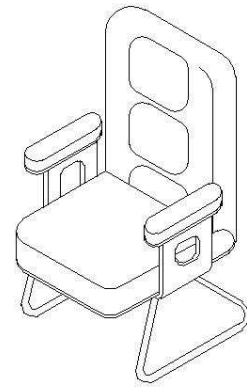
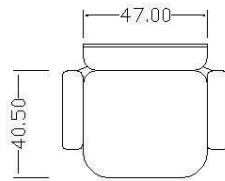

TAMPAK DEPAN

TAMPAK SAMPING

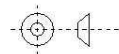

SKALA : 1:20  
SATUAN : cm  
TANGGAL : 05-03-08

DIGAMBAR:  
DILIHAT:

Kursi Staff dan Pengunjung  
Alternatif 1

PROYEKSI AMERIKA

A4

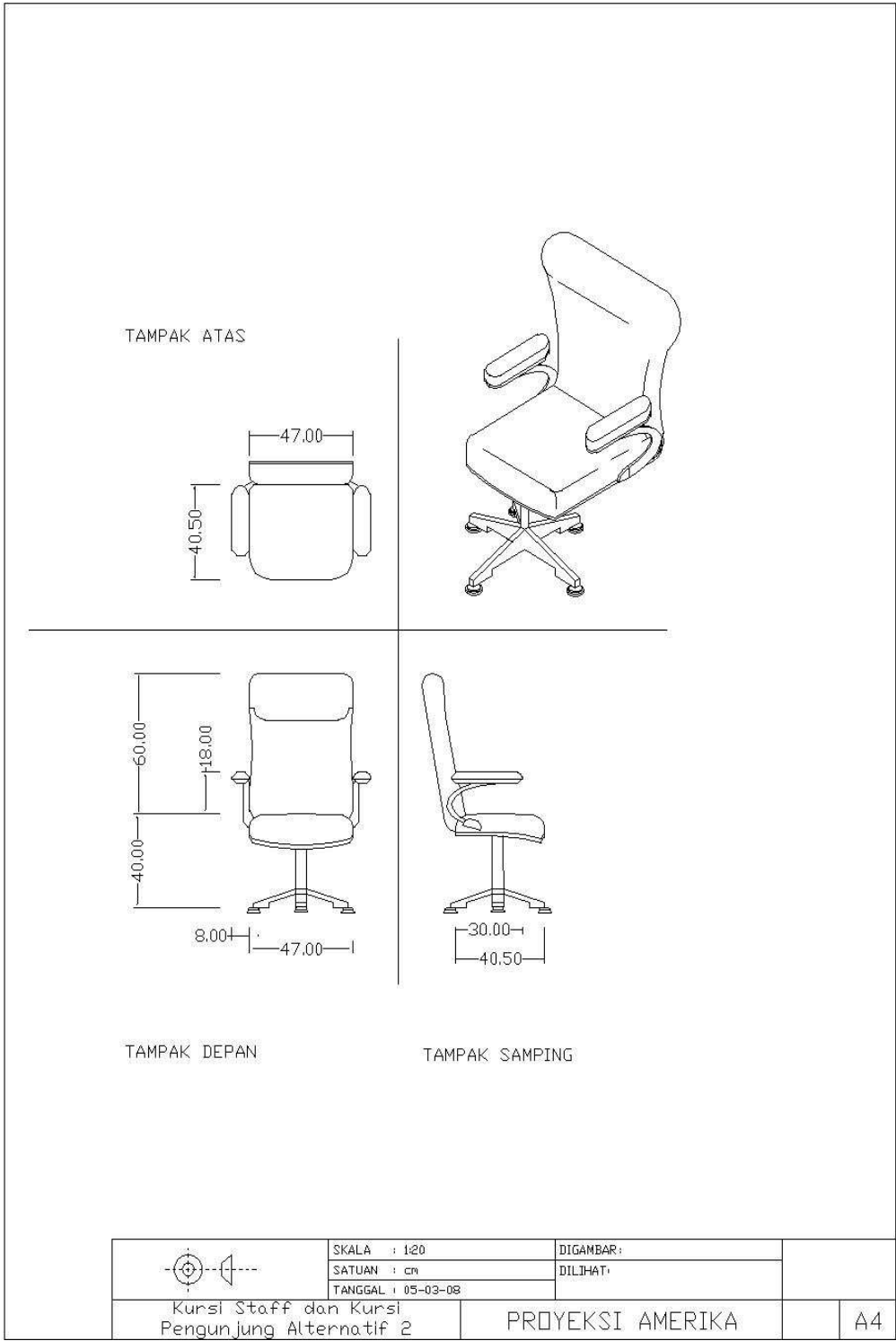

TAMPAK ATAS

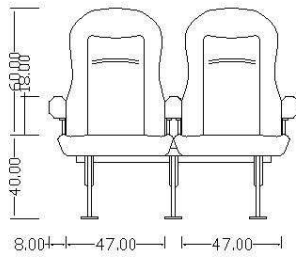
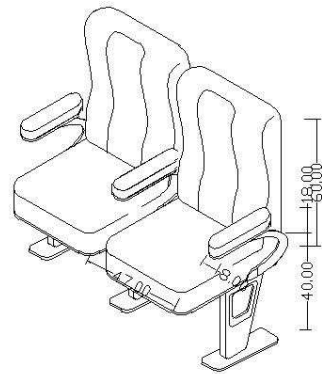
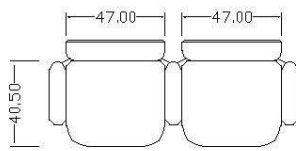

TAMPAK DEPAN

TAMPAK SAMPING

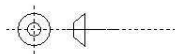

SKALA : 1:20  
SATUAN : cm  
TANGGAL : 05-03-08

DIGAMBAR:  
DILIHAT:

Kursi Staff dan Kursi  
Pengunjung Alternatif 3

PROYEKSI AMERIKA

A4

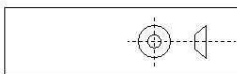
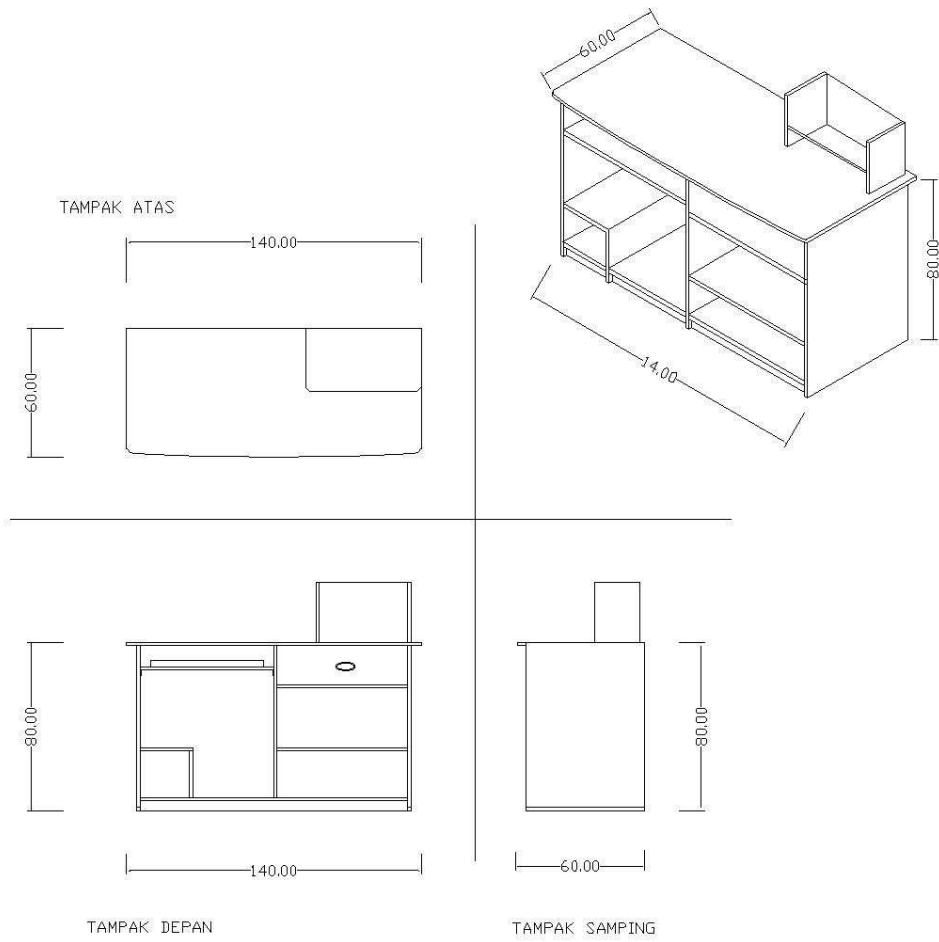

SKALA : 1:20  
 SATUAN : cm  
 TANGGAL : 05-03-08

DIGAMBAR:  
 DILIHAT:

Meja Staff Alternatif 1

PROYEKSI AMERIKA

A4

TAMPAK ATAS

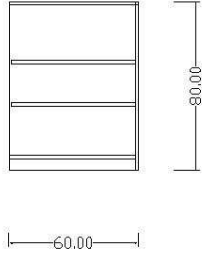
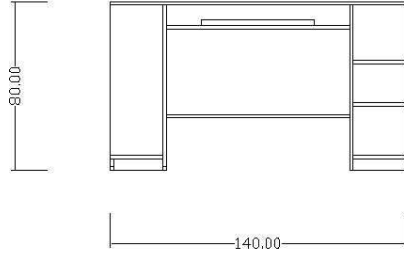
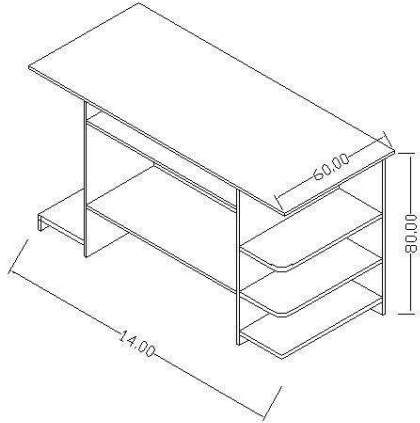
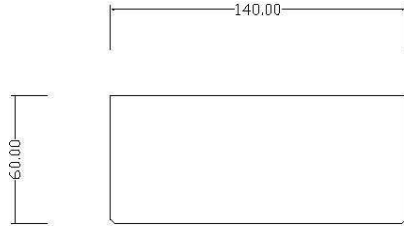

TAMPAK DEPAN

TAMPAK SAMPING

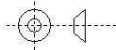

SKALA : 1:20  
 SATUAN : cm  
 TANGGAL : 05-03-08

DIGAMBAR:  
 DILIHAT:

Meja Staff Alternatif 2

PROYEKSI AMERIKA

A4

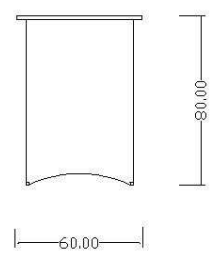
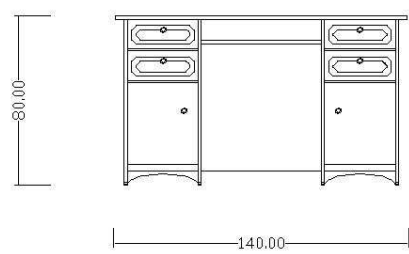
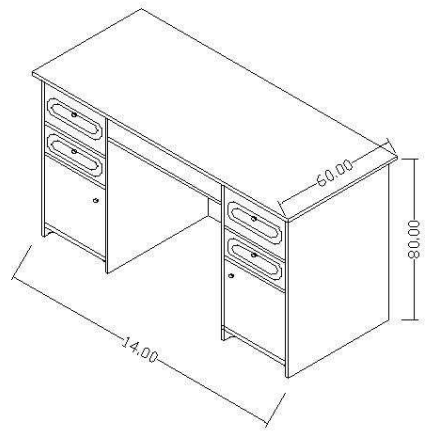
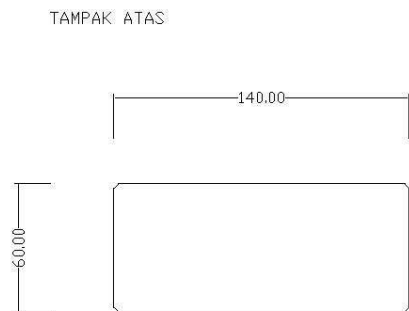

TAMPAK DEPAN

TAMPAK SAMPING

TAMPAK DEPAN

TAMPAK SAMPING

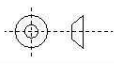

SKALA : 1:20  
 SATUAN : cm  
 TANGGAL : 05-03-08

DIGAMBAR:  
 DILIHAT:

Meja Staff Alternatif 3

PROYEKSI AMERIKA

A4

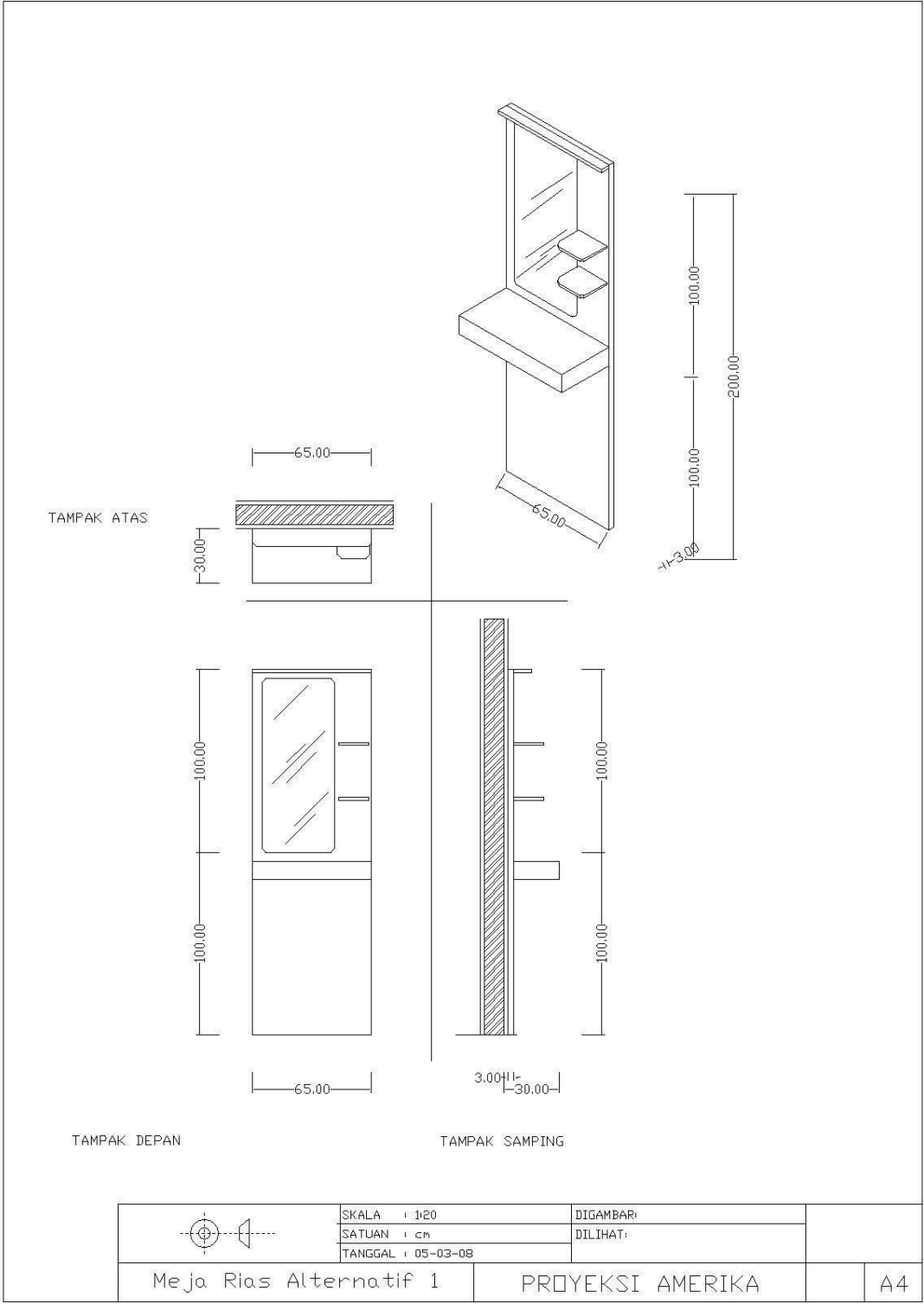

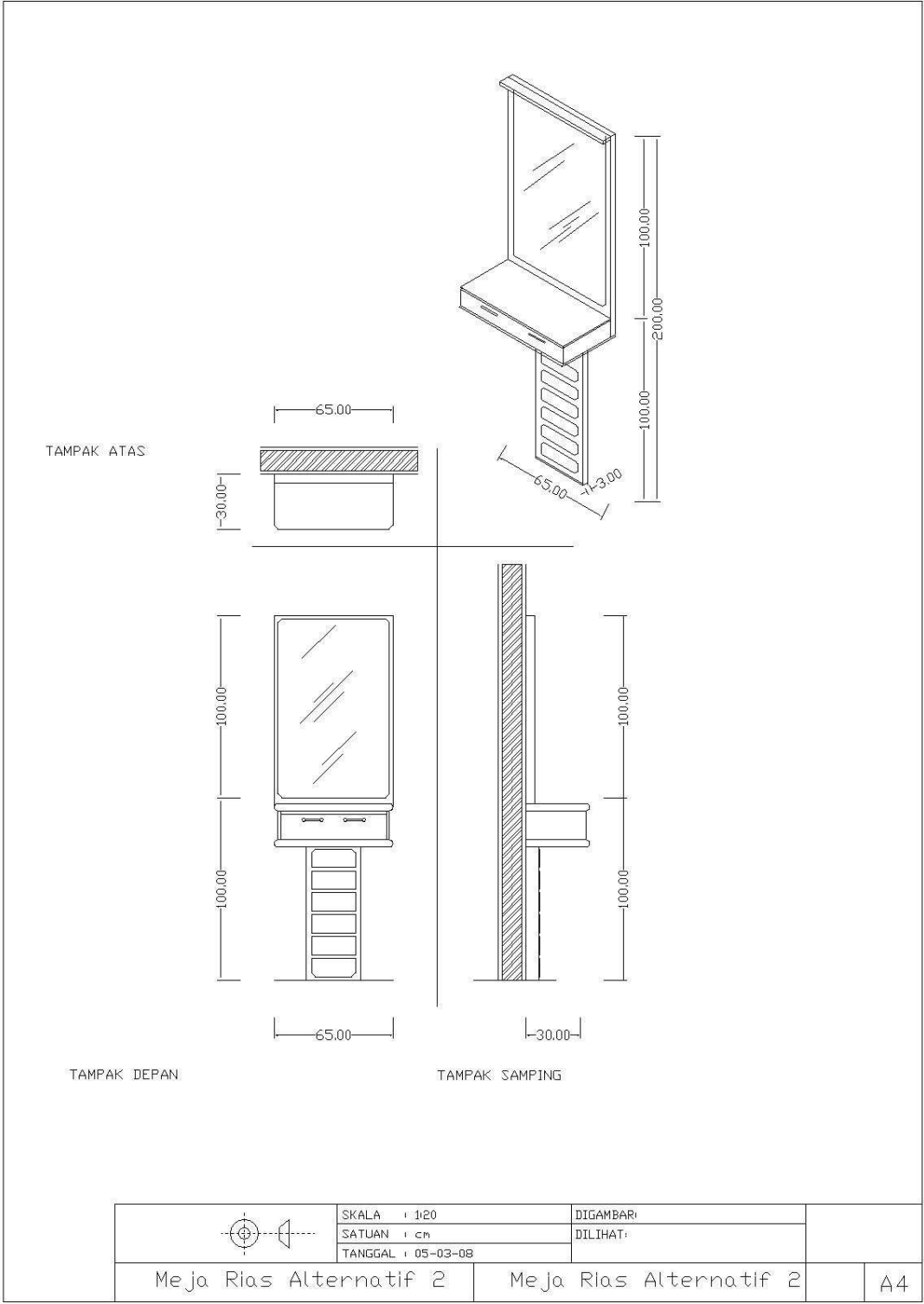



TAMPAK ATAS

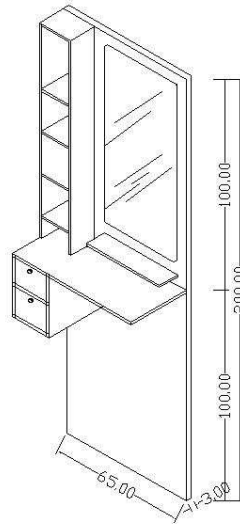
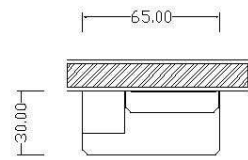

ISOMETRIK

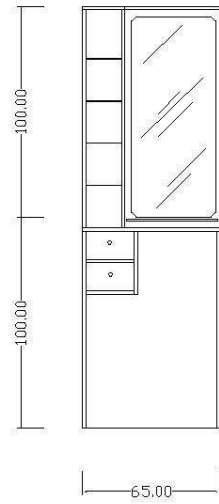

TAMPAK DEPAN

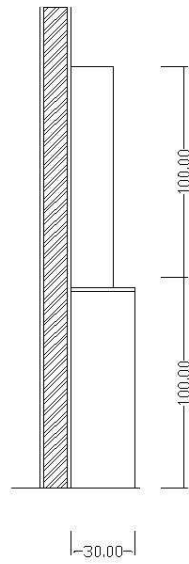

TAMPAK SAMPING

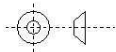

SKALA : 1:20

SATUAN : cm

TANGGAL : 05-03-08

DIGAMBAR:

DILIHAT:

Meja Rias Alternatif 3

PROYEKSI AMERIKA

A4

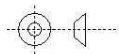
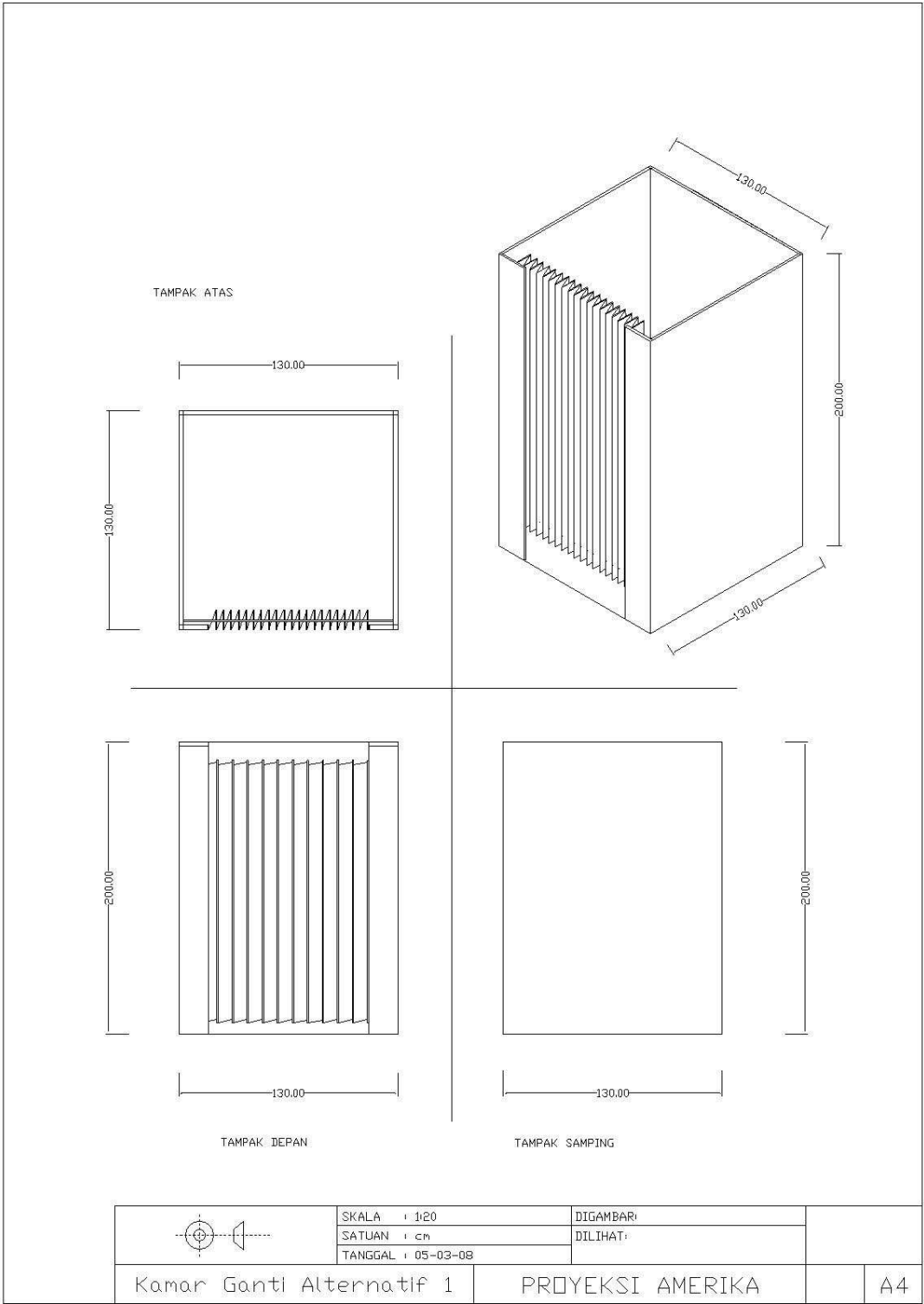

SKALA : 1:20  
 SATUAN : cm  
 TANGGAL : 05-03-08

DIGAMBAR:  
 DILIHAT:

Kamar Ganti Alternatif 1

PROYEKSI AMERIKA

A4

TAMPAK ATAS

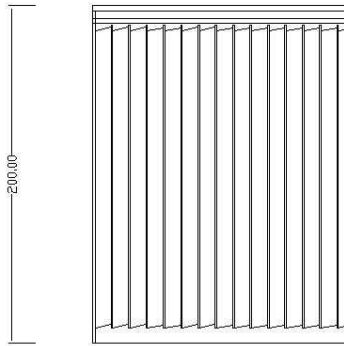
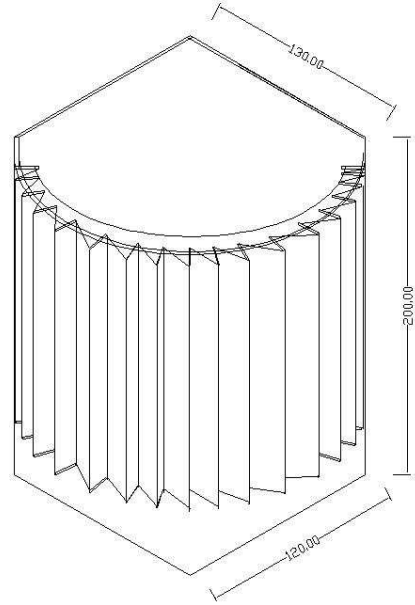
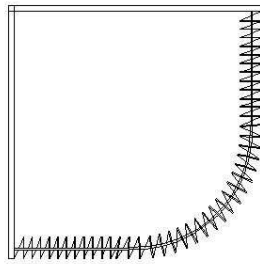

TAMPAK DEPAN

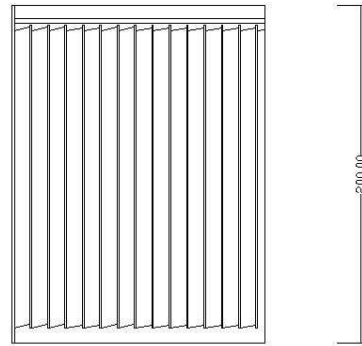

TAMPAK SAMPING

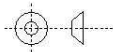

SKALA : 1:20  
SATUAN : cm  
TANGGAL : 05-03-08

DIGAMBAR:  
DILIHAT:

Kamar Ganti Alternatif 2

PROYEKSI AMERIKA

A4

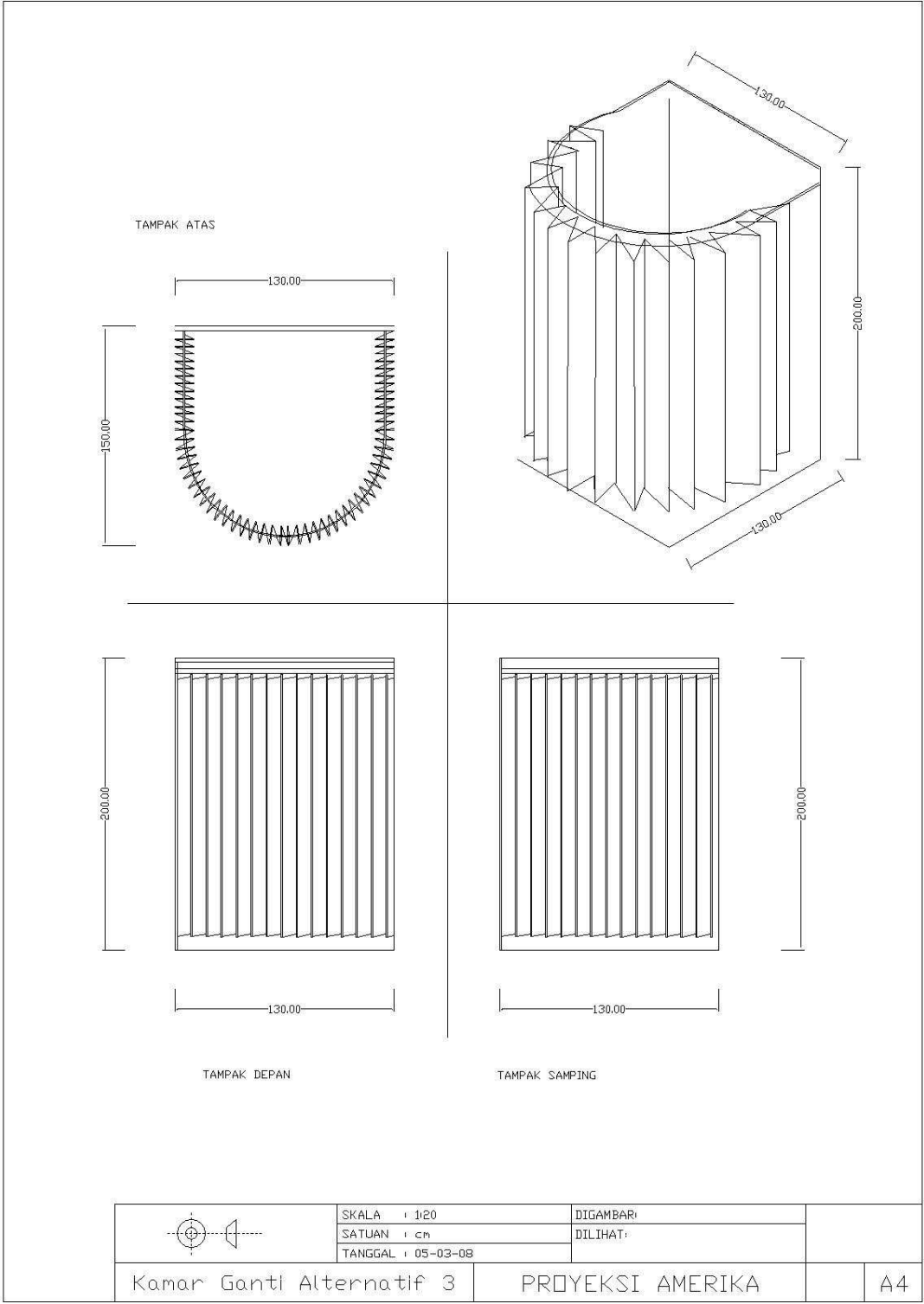

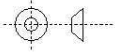
	SKALA : 1:20	DIGAMBAR:	
	SATUAN : cm	DILIHAT:	
	TANGGAL : 05-03-08		
Kamar Ganti Alternatif 3		PROYEKSI AMERIKA	A4

TAMPAK ATAS

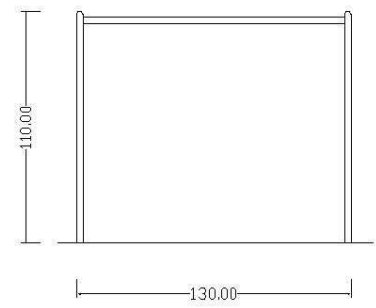
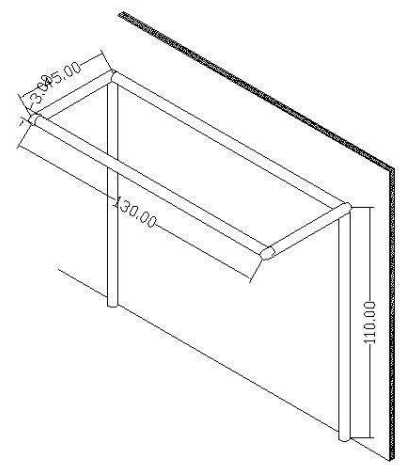
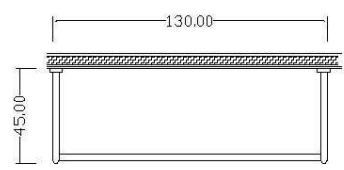

TAMPAK DEPAN

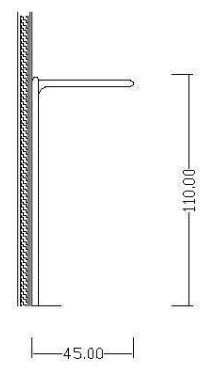

TAMPAK SAMPING

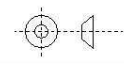

SKALA : 1:20  
SATUAN : cm  
TANGGAL : 05-03-08

DIGAMBAR:  
DILIHAT:

Tempat Gantungan Baju  
Alternatif 1

PROYEKSI AMERIKA

A4

TAMPAK ATAS

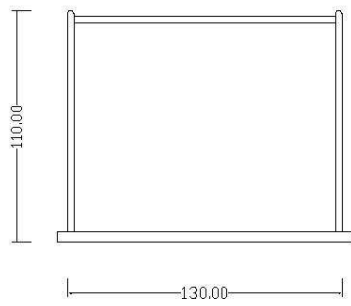
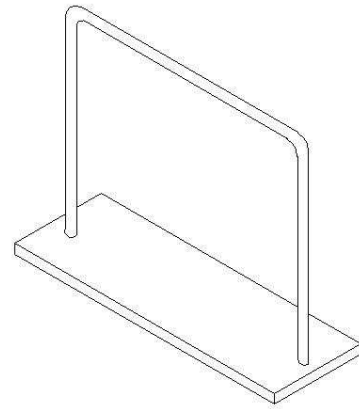

TAMPAK DEPAN

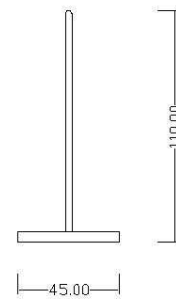

TAMPAK SAMPING

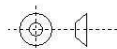

SKALA : 1:20

SATUAN : cm

TANGGAL : 05-03-08

DIGAMBAR:

DILIHAT:

Tempat Gantungan Baju  
Alternatif 2

PROYEKSI AMERIKA

A4

TAMPAK ATAS

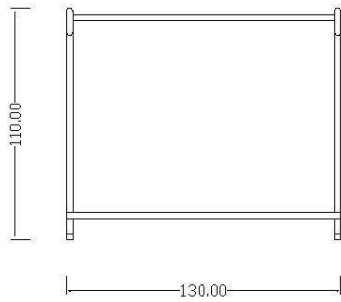
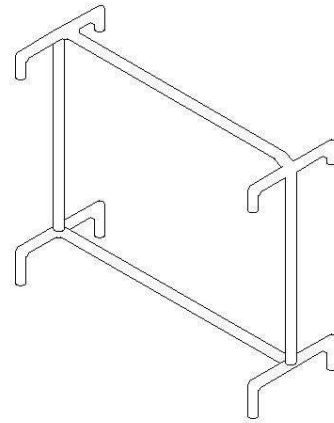
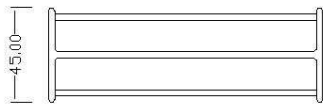

TAMPAK DEPAN

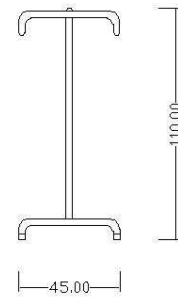

TAMPAK SAMPING

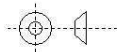

SKALA : 1:20  
SATUAN : cm  
TANGGAL : 05-03-08

DIGAMBAR:  
DILIHAT:

Tempat Gantungan Baju  
Alternatif 3

PROYEKSI AMERIKA

A4