

Row Arrangement

		Mesin												
		1	2	3	4	5	6	7	8	9	10	11	12	13
Komponen	29	1	2	3	4	5	6	7	8	9	10	11	12	13
	28	2	4	6	12	13	1	3	5	7	8	9	10	11
	27	2	12	13	3	11	4	6	1	5	7	8	9	10
	26	2	13	11	6	1	5	12	3	4	7	8	9	10
	25	2	13	6	4	11	1	5	12	3	7	8	9	10
	24	2	13	6	4	11	1	5	12	3	7	8	9	10
	23	2	13	11	6	4	1	5	12	3	7	8	9	10
	22	2	13	11	6	4	1	5	12	3	7	8	9	10
	21	2	6	4	5	13	11	1	12	3	7	8	9	10
	20	2	13	11	12	3	6	4	5	1	7	8	9	10
	19	2	13	11	12	3	6	4	5	1	7	8	9	10
	18	6	4	7	2	13	11	12	3	5	1	8	9	10
	17	5	1	10	6	4	7	2	13	11	12	3	8	9
	16	1	4	7	5	10	6	2	13	11	12	3	8	9
	15	1	4	7	5	10	6	2	13	11	12	3	8	9
	14	1	4	7	5	10	6	2	13	11	12	3	8	9
	13	4	7	6	1	5	10	2	13	11	12	3	8	9
	12	1	5	10	4	7	6	2	13	11	12	3	8	9
	11	1	4	7	5	10	6	2	13	11	12	3	8	9
	10	1	4	7	5	10	6	2	13	11	12	3	8	9
	9	1	4	7	5	10	6	2	13	11	12	3	8	9
	8	1	10	6	8	9	4	7	5	2	13	11	12	3
	7	1	10	6	8	9	4	7	5	2	13	11	12	3
	6	1	4	5	10	6	8	9	7	2	13	11	12	3
	5	1	4	5	10	6	8	9	7	2	13	11	12	3
	4	1	4	5	10	6	8	9	7	2	13	11	12	3
	3	1	5	4	10	6	8	9	7	2	13	11	12	3
	2	1	5	4	10	6	8	9	7	2	13	11	12	3
	1	5	1	4	10	6	8	9	7	2	13	11	12	3
	1	6	5	4	10	8	9	7	2	13	11	12	3	

Matriks 1A

Mesin	Komponen																													
	1	2	3	4	5	6	7	8	9	10	11	12	13	14	15	16	17	18	19	20	21	22	23	24	25	26	27	28	29	
1	1		1	1	1	1	1	1	1	1	1	1	1	1	1	1	1	1												1
6	1							1	1					1		1			1			1			1	1	1		1	
5		1	1	1			1					1						1				1								
4					1		1			1		1		1	1		1		1			1				1			1	
10								1	1			1						1												
8								1	1																					
9								1	1																					
7												1		1			1		1											
2																					1	1	1	1	1	1	1	1	1	
13																					1	1		1	1	1	1	1	1	
11																					1	1		1	1			1	1	
12																					1	1							1	
3																					1	1							1	

Column Arrangement

Mesin	Komponen																																			
3	1	2	3	4	5	6	7	8	9	10	11	12	13	14	15	16	17	18	19	20	21	22	23	24	25	26	27	28	29							
12	20	21	28	1	2	3	4	5	6	7	8	9	10	11	12	13	14	15	16	17	18	19	22	23	24	25	26	27	29							
11	20	21	28	29	1	2	3	4	5	6	7	8	9	10	11	12	13	14	15	16	17	18	19	22	23	24	25	26	27							
13	20	21	28	23	24	27	29	1	2	3	4	5	6	7	8	9	10	11	12	13	14	15	16	17	18	19	22	25	26							
2	20	21	28	23	24	27	29	25	26	1	2	3	4	5	6	7	8	9	10	11	12	13	14	15	16	17	18	19	22							
7	20	21	28	23	24	27	29	25	26	22	1	2	3	4	5	6	7	8	9	10	11	12	13	14	15	16	17	18	19							
9	12	14	17	19	20	21	28	23	24	27	29	25	26	22	1	2	3	4	5	6	7	8	9	10	11	13	15	16	18							
8	8	9	12	14	17	19	20	21	28	23	24	27	29	25	26	22	1	2	3	4	5	6	7	10	11	13	15	16	18							
10	8	9	12	14	17	19	20	21	28	23	24	27	29	25	26	22	1	2	3	4	5	6	7	10	11	13	15	16	18							
4	8	9	13	18	12	14	17	19	20	21	28	23	24	27	29	25	26	22	1	2	3	4	5	6	7	10	11	15	16							
5	12	14	17	19	29	26	22	5	7	10	15	8	9	13	18	20	21	28	23	24	27	25	1	2	3	4	6	11	16							
6	22	7	13	18	27	2	3	4	12	14	17	19	29	26	5	10	15	8	9	20	21	28	23	24	25	1	6	11	16							
1	22	27	14	19	29	26	8	9	25	1	7	13	18	2	3	4	12	17	19	29	26	5	10	15	8	9	20	21	28	23	24	25	1	6	11	16
	27	8	9	1	7	13	18	3	4	12	17	5	10	15	6	11	16	22	14	19	29	26	25	2	20	21	28	23	24							

Matriks 1 B

Mesin	Komponen																													
	27	8	9	1	7	13	18	3	4	12	17	5	10	15	6	11	16	22	14	19	29	26	25	2	20	21	28	23	24	
1	1	1	1	1	1	1	1	1	1	1	1	1	1	1	1	1	1													
6	1	1	1	1														1	1	1	1	1	1							
5	1																	1							1					
4					1													1	1	1	1	1								
10		1	1															1	1	1	1	1								
8		1	1																											
9		1	1																											
7										1	1																			
2	1																	1		1	1				1	1	1	1	1	
13	1																								1	1	1	1	1	
11	1																								1	1	1	1	1	
12																										1	1	1		
3																										1	1	1		

Matriks awal 2

Mesin	Komponen																													
	27	8	9	1	7	13	18	3	4	12	17	5	10	15	6	11	16	22	14	19	29	26	25	2	20	21	28	23	24	
1	1	1	1	1	1	1	1	1	1	1	1	1	1	1	1	1	1													
6	1	1	1	1														1	1	1	1	1	1							
5	1				1	1	1	1	1									1							1					
4					1					1	1	1	1	1				1	1	1	1	1								
10		1	1			1	1																							
8		1	1																											
9		1	1																											
7										1	1																			
2	1																	1		1		1	1		1	1	1	1	1	1
13	1																					1	1	1		1	1	1	1	1
11	1																									1	1	1	1	1
12																						1				1	1	1	1	1
3																										1	1	1	1	1

Row Arrangement

No	Mesin												
	1 (1)	2(6)	3(5)	4(4)	5(10)	6(8)	7(9)	8(7)	9(2)	10(13)	11(11)	12(12)	13(3)
24	1	2	3	4	5	6	7	8	9	10	11	12	13
23	9	10	11	1	2	3	4	5	6	7	8	12	13
28	9	10	11	1	2	3	4	5	6	7	8	12	13
21	9	10	11	12	13	1	2	3	4	5	6	7	8
20	9	10	11	12	13	1	2	3	4	5	6	7	8
2	9	10	11	12	13	1	2	3	4	5	6	7	8
25	3	9	10	11	12	13	1	2	4	5	6	7	8
26	9	10	2	3	11	12	13	1	4	5	6	7	8
29	9	10	2	4	3	11	12	13	1	5	6	7	8
19	9	10	2	4	12	3	11	13	1	5	6	7	8
14	2	4	8	9	10	12	3	11	13	1	5	6	7
22	2	4	8	9	10	12	3	11	13	1	5	6	7
16	2	4	9	3	8	10	12	11	13	1	5	6	7
11	1	2	4	9	3	8	10	12	11	13	5	6	7
6	1	2	4	9	3	8	10	12	11	13	5	6	7
15	1	2	4	9	3	8	10	12	11	13	5	6	7
10	1	4	2	9	3	8	10	12	11	13	5	6	7
5	1	4	2	9	3	8	10	12	11	13	5	6	7
17	1	4	2	9	3	8	10	12	11	13	5	6	7
12	1	4	2	9	3	8	10	12	11	13	5	6	7
17	1	4	2	9	3	8	10	12	11	13	5	6	7
12	1	4	2	9	3	8	10	12	11	13	5	6	7
4	1	4	8	2	9	3	10	12	11	13	5	6	7
3	1	3	4	8	2	9	10	12	11	13	5	6	7
18	1	3	4	8	2	9	10	12	11	13	5	6	7
13	1	3	5	4	8	2	9	10	12	11	13	6	7
7	1	3	5	4	8	2	9	10	12	11	13	6	7
1	1	3	4	5	8	2	9	10	12	11	13	6	7
9	1	2	3	4	5	8	9	10	12	11	13	6	7
8	1	2	5	6	7	3	4	8	9	10	12	11	13
27	1	2	5	6	7	3	4	8	9	10	12	11	13

Matriks 2A

Mesin	Komponen																												
	27	8	9	1	7	13	18	3	4	12	17	5	10	15	6	11	16	22	14	19	29	26	25	2	20	21	28	23	24
1	1	1	1	1	1	1	1	1	1	1	1	1	1	1	1	1	1												
6	1	1	1	1														1	1	1	1	1	1						
5	1				1	1	1	1	1									1						1					
2	1																	1											
13	1																				1	1	1		1	1	1	1	1
11	1																								1	1	1	1	1
10		1	1			1	1																						
8		1	1																										
9		1	1																										
4					1						1	1	1	1	1			1	1	1	1	1							
7											1	1							1	1									
12																						1			1	1	1		
3																									1	1	1		

Column Arrangement

Mesin	Komponen																												
3	1	2	3	4	5	6	7	8	9	10	11	12	13	14	15	16	17	18	19	20	21	22	23	24	25	26	27	28	29
12	25	26	27	1	2	3	4	5	6	7	8	9	10	11	12	13	14	15	16	17	18	19	20	21	22	23	24	28	29
7	25	26	27	21	1	2	3	4	5	6	7	8	9	10	11	12	13	14	15	16	17	18	19	20	22	23	24	28	29
4	10	11	19	20	25	26	27	21	1	2	3	4	5	6	7	8	9	12	13	14	15	16	17	18	22	23	24	28	29
9	10	11	19	20	21	5	12	13	14	18	22	25	26	27	1	2	3	4	6	7	8	9	15	16	17	23	24	28	29
8	2	3	10	11	19	20	21	5	12	13	14	18	22	25	26	27	1	4	6	7	8	9	15	16	17	23	24	28	29
10	2	3	10	11	19	20	21	5	12	13	14	18	22	25	26	27	1	4	6	7	8	9	15	16	17	23	24	28	29
11	2	3	6	7	10	11	19	20	21	5	12	13	14	18	22	25	26	27	1	4	8	9	15	16	17	23	24	28	29
13	25	26	27	1	28	29	2	3	6	7	10	11	19	20	21	5	12	13	14	18	22	4	8	9	15	16	17	23	24
2	25	26	27	1	28	29	21	22	23	2	3	6	7	10	11	19	20	5	12	13	14	18	4	8	9	15	16	17	24
5	25	26	27	1	28	29	21	22	23	18	2	3	6	7	10	11	19	20	5	12	13	14	4	8	9	15	16	17	24
6	1	18	6	7	5	8	9	24	25	26	27	28	29	21	22	23	2	3	10	11	19	20	12	13	14	4	15	16	17
1	1	18	21	22	23	2	3	19	20	4	6	7	5	8	9	24	25	26	27	28	29	10	11	12	13	14	15	16	17

1(27) 2(8) 3(9) 4(1) 6(13) 7(18) 5(7) 8(3) 9(4) 10(12) 11(17) 12(5) 13(10) 14(15) 15(6) 16(11) 17(16) 18(22) 21(29) 22(26) 23(25) 19(14) 20(19) 24(2) 25(20) 26(21) 27(28) 28(23) 29(24)

Matriks 2B

Mesin	Komponen																												
	27	8	9	1	13	18	7	3	4	12	17	5	10	15	6	11	16	22	29	26	25	14	19	2	20	21	28	23	24
1	1	1	1	1	1	1	1	1	1	1	1	1	1	1	1	1	1												
6	1	1	1	1														1	1	1	1	1	1						
5	1				1	1	1	1	1									1						1					
2	1																	1	1	1	1				1	1	1	1	1
13	1																		1	1	1				1	1	1	1	1
11	1																								1	1	1	1	1
10		1	1		1	1																							
8		1	1																										
9		1	1																										
4							1			1	1	1	1	1				1	1	1		1	1						
7										1	1											1	1						
12																				1						1	1	1	
3																									1	1	1		

Matriks Awal 3

Mesin	Komponen																												
	27	8	9	1	13	18	7	3	4	12	17	5	10	15	6	11	16	22	29	26	25	14	19	2	20	21	28	23	24
1	1	1	1	1	1	1	1	1	1	1	1	1	1	1	1	1	1												
6	1	1	1	1														1	1	1	1	1	1						
5	1				1	1	1	1	1									1						1					
2	1																	1	1	1	1					1	1	1	1
13	1																		1	1	1					1	1	1	1
11	1																									1	1	1	1
10		1	1		1	1																							
8		1	1																										
9		1	1																										
4							1				1	1	1	1	1			1	1	1		1	1						
7										1	1											1	1						
12																			1							1	1	1	
3																				1						1	1	1	

Row Arrangement

No	Mesin												
	1 (1)	2(6)	3(5)	4(2)	5(13)	6(11)	7(10)	8(8)	9(9)	10(4)	11(7)	12(12)	13(3)
24	1	2	3	4	5	6	7	8	9	10	11	12	13
23	4	5	6	1	2	3	7	8	9	10	11	12	13
28	4	5	6	1	2	3	7	8	9	10	11	12	13
21	4	5	6	12	13	1	2	3	7	8	9	10	11
20	4	5	6	12	13	1	2	3	7	8	9	10	11
2	4	5	6	12	13	1	2	3	7	8	9	10	11
19	3	4	5	6	12	13	1	2	7	8	9	10	11
14	2	10	11	3	4	5	6	12	13	1	7	8	9
25	2	10	11	3	4	5	6	12	13	1	7	8	9
26	2	4	5	10	11	3	6	12	13	1	7	8	9
29	2	4	5	10	11	3	6	12	13	1	7	8	9
22	2	4	5	10	12	11	3	6	13	1	7	8	9
16	2	4	10	3	5	12	11	6	13	1	7	8	9
11	1	2	4	10	3	5	12	11	6	13	7	8	9
6	1	2	4	10	3	5	12	11	6	13	7	8	9
15	1	2	4	10	3	5	12	11	6	13	7	8	9
10	1	10	2	4	3	5	12	11	6	13	7	8	9
5	1	10	2	4	3	5	12	11	6	13	7	8	9
17	1	10	2	4	3	5	12	11	6	13	7	8	9
12	1	10	11	2	4	3	5	12	6	13	7	8	9
4	1	10	11	2	4	3	5	12	6	13	7	8	9
3	1	3	10	11	2	4	5	12	6	13	7	8	9
7	1	3	10	11	2	4	5	12	6	13	7	8	9
18	1	3	10	11	2	4	5	12	6	13	7	8	9
13	1	3	7	10	11	2	4	5	12	6	13	8	9
1	1	3	7	10	11	2	4	5	12	6	13	8	9
9	1	2	3	7	10	11	4	5	12	6	13	8	9
8	1	2	7	8	9	3	10	11	4	5	12	6	13
27	1	2	7	8	9	3	10	11	4	5	12	6	13

Matriks 3A

Mesin	Komponen																												
	27	8	9	1	13	18	7	3	4	12	17	5	10	15	6	11	16	22	29	26	25	14	19	2	20	21	28	23	24
1	1	1	1	1	1	1	1	1	1	1	1	1	1	1	1	1	1												
6	1	1	1	1														1	1	1	1	1	1						
5	1				1	1	1	1	1									1	1	1	1			1					
2	1																	1	1	1	1				1	1	1	1	1
13	1																		1	1	1				1	1	1	1	1
11	1																								1	1	1	1	1
10		1	1		1	1																							
8		1	1																										
9		1	1																										
4							1			1	1	1	1	1				1	1	1		1	1						
7										1	1											1	1						
12																			1						1	1	1		
3																									1	1	1		

Column Arrangement

Mesin	Komponen																												
3	1	2	3	4	5	6	7	8	9	10	11	12	13	14	15	16	17	18	19	20	21	22	23	24	25	26	27	28	29
12	25	26	27	1	2	3	4	5	6	7	8	9	10	11	12	13	14	15	16	17	18	19	20	21	22	23	24	28	29
7	25	26	27	19	1	2	3	4	5	6	7	8	9	10	11	12	13	14	15	16	17	18	20	21	22	23	24	28	29
4	10	11	22	23	25	26	27	19	1	2	3	4	5	6	7	8	9	12	13	14	15	16	17	18	20	21	24	28	29
9	10	11	22	23	19	7	12	13	14	18	20	25	26	27	1	2	3	4	5	6	8	9	15	16	17	21	24	28	29
8	2	3	10	11	22	23	19	7	12	13	14	18	20	25	26	27	1	4	5	6	8	9	15	16	17	21	24	28	29
10	2	3	10	11	22	23	19	7	12	13	14	18	20	25	26	27	1	4	5	6	8	9	15	16	17	21	24	28	29
11	2	3	5	6	10	11	22	23	19	7	12	13	14	18	20	25	26	27	1	4	8	9	15	16	17	21	24	28	29
13	25	26	27	1	28	29	2	3	5	6	10	11	22	23	19	7	12	13	14	18	20	4	8	9	15	16	17	21	24
2	25	26	27	1	28	29	19	20	21	2	3	5	6	10	11	22	23	7	12	13	14	18	4	8	9	15	16	17	24
5	25	26	27	1	28	29	19	20	21	18	2	3	5	6	10	11	22	23	7	12	13	14	4	8	9	15	16	17	24
6	1	18	5	6	7	8	9	24	25	26	27	28	29	19	20	21	2	3	10	11	22	23	12	13	14	4	15	16	17
1	1	18	19	20	21	2	3	22	23	4	5	6	7	8	9	24	25	26	27	28	29	10	11	12	13	14	15	16	17
	1	2	3	4	5	6	7	8	9	10	11	12	13	14	15	16	17	18	19	20	21	22	23	24	25	26	27	28	29

Matriks 3B

Mesin	Komponen																												
	27	8	9	1	13	18	7	3	4	12	17	5	10	15	6	11	16	22	29	26	25	14	19	2	20	21	28	23	24
1	1	1	1	1	1	1	1	1	1	1	1	1	1	1	1	1	1												
6																		1	1	1	1	1	1						
5	1	1	1	1														1						1					
2	1																	1	1	1	1				1	1	1	1	1
13	1																								1	1	1	1	1
11	1																								1	1	1	1	1
10		1	1		1	1																							
8		1	1																										
9		1	1																										
4							1				1	1	1	1	1			1	1	1		1	1						
7											1	1										1	1						
12																									1	1	1		
3																									1	1	1		

Matriks Akhir

MESIN	27	8	9	1	13	18	7	3	4	12	17	5	10	15	6	11	16	22	29	26	25	14	19	2	20	21	28	23	24	
1	1	1	1	1	1	1	1	1	1	1	1	1	1	1	1	1	1													
6	1	1	1	1														1	1	1	1	1	1							
5	1				1	1	1	1	1									1						1						
2	1																	1	1	1	1				1	1	1	1	1	
13	1																		1	1	1				1	1	1	1	1	
11	1																								1	1	1	1	1	
10		1	1		1	1																								
8		1	1																											
9		1	1																											
4						1				1	1	1	1	1				1	1	1		1	1							
7										1	1											1	1							
12																			1						1	1	1			
3																									1	1	1			
	1	2	3	4	5	6	7	8	9	10	11	12	13	14	15	16	17	18	19	20	21	22	23	24	25	26	27	28	29	

Jarak tata letak awal

Jarak Antara mesin departemen *brake pedal*

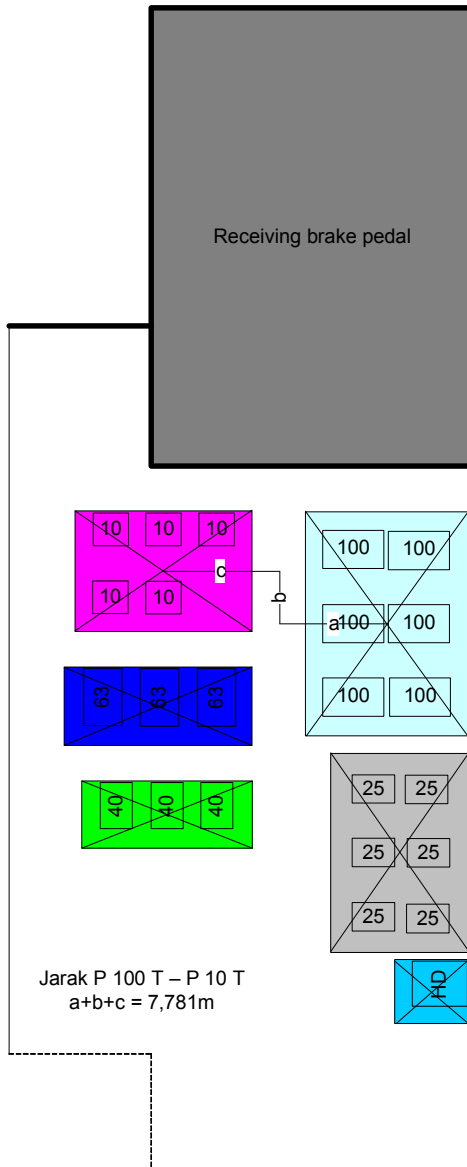

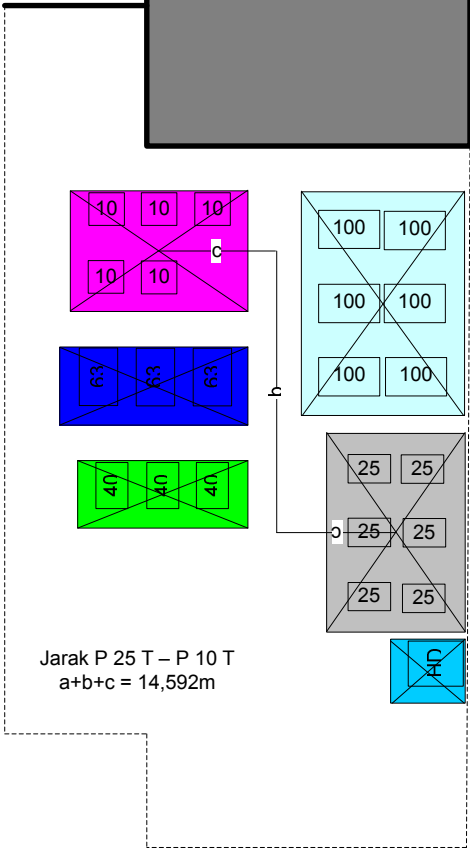
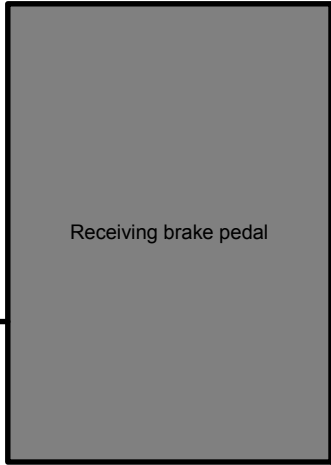

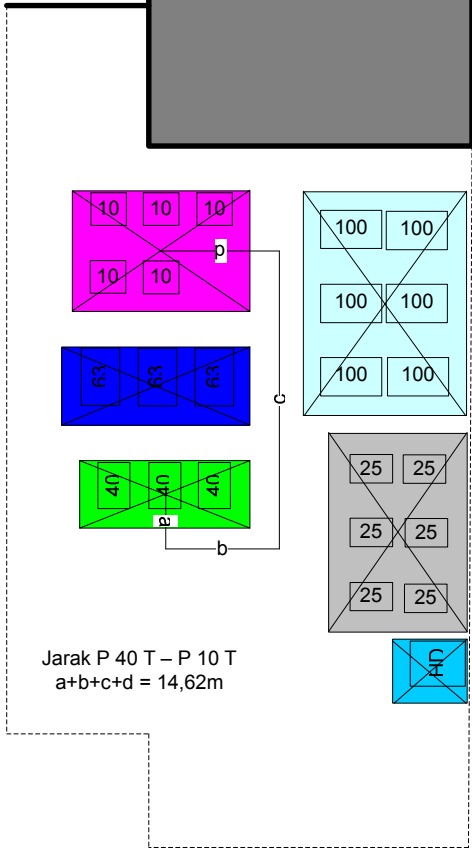
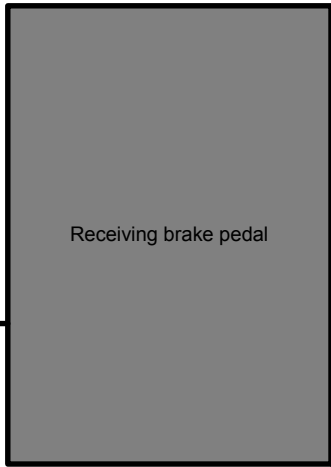

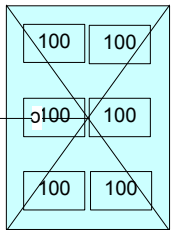
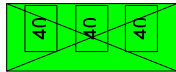
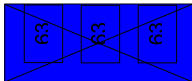
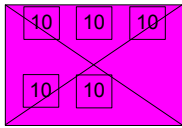
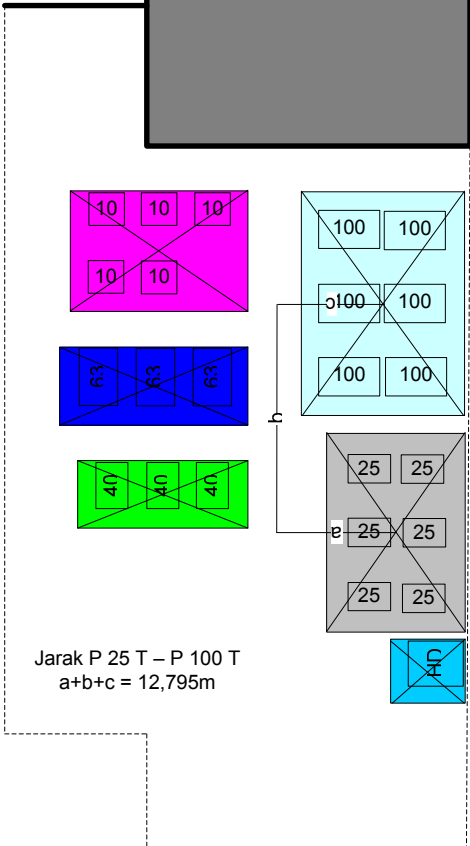
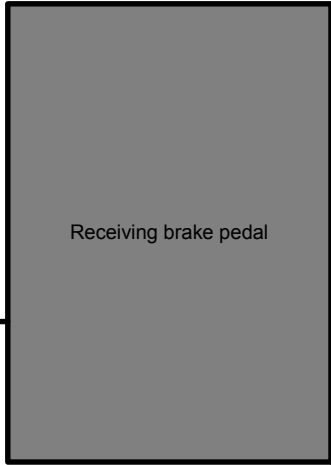

b

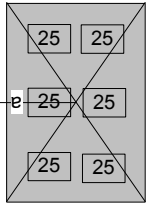

a



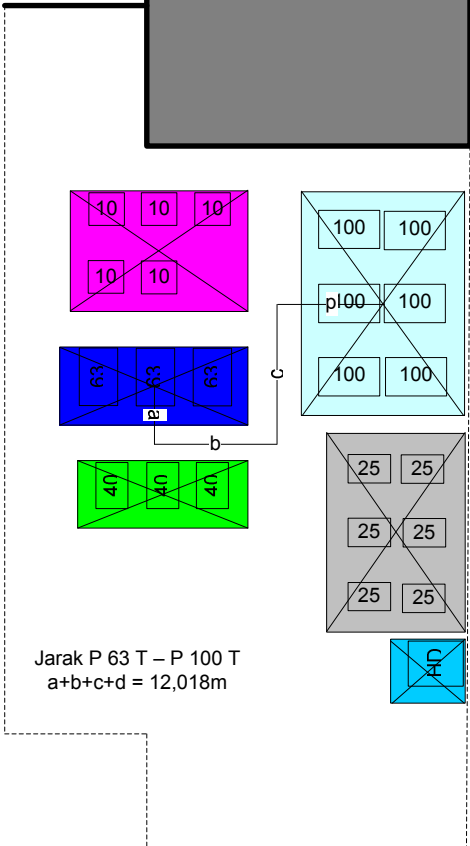
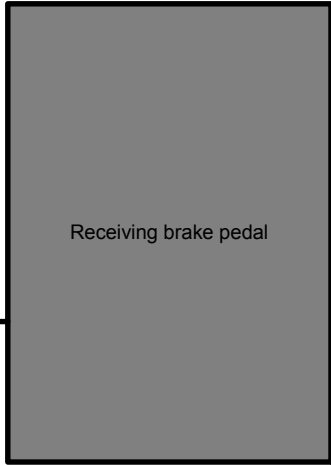

Jarak P 63 T – P 100 T
 $a+b+c+d = 12,018m$

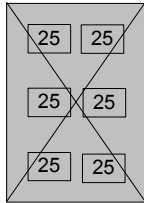
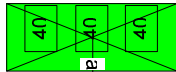
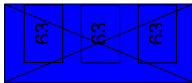
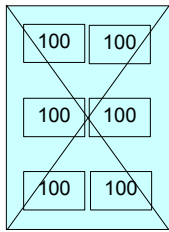
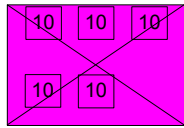
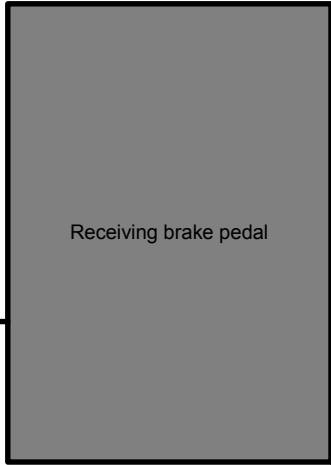

Jarak P 40 T – P HD
 $a+b+c = 12,481\text{m}$

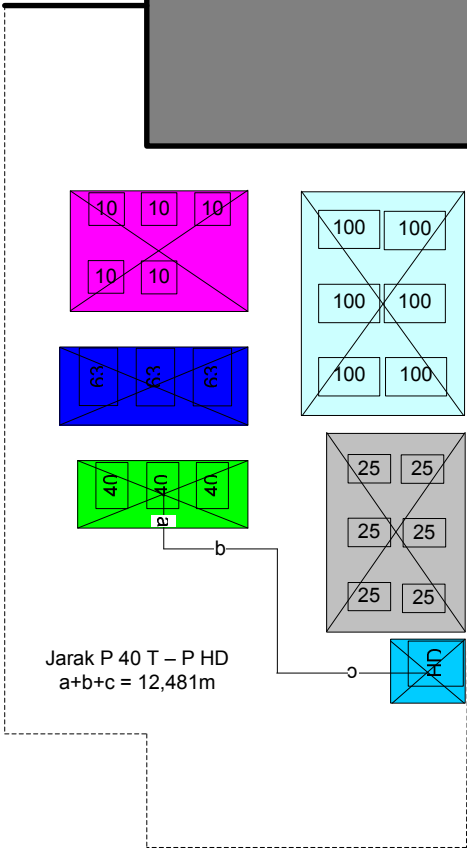

Jarak Antara mesin departemen *pipe frame head*

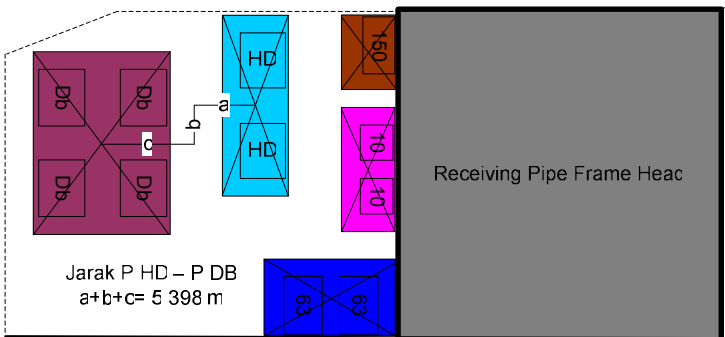
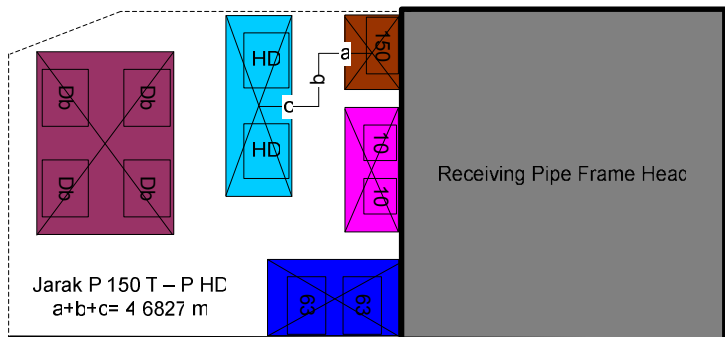
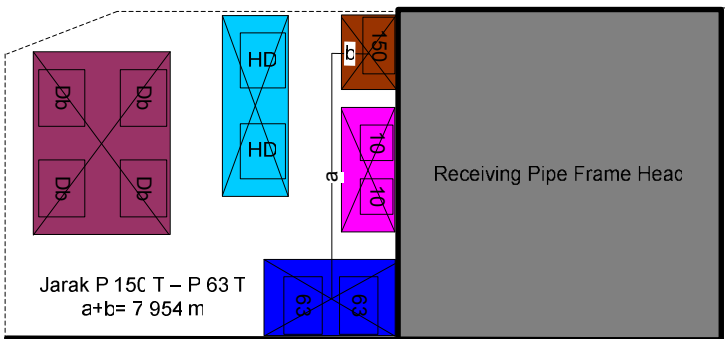
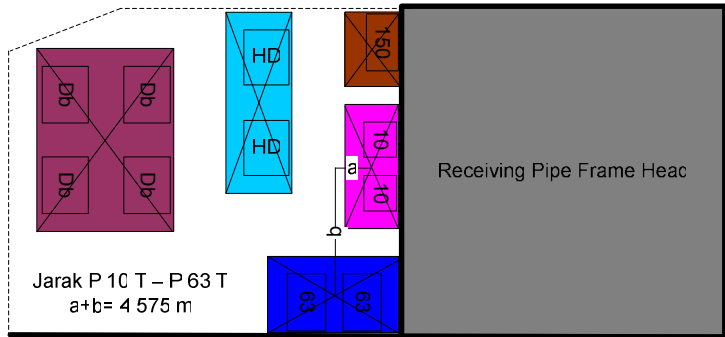

Jarak Antara mesin departemen *multi part*

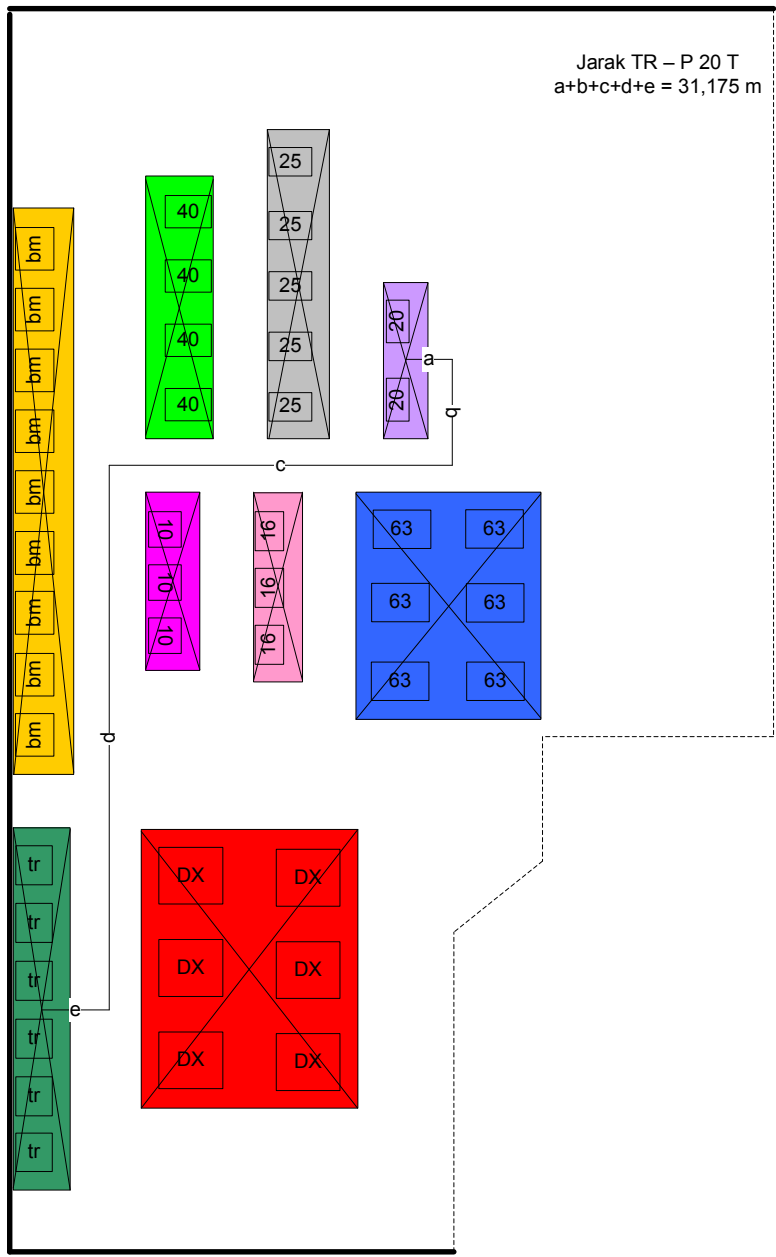

Jarak P 20 T – BM
 $a+b+c+d+e = 16,564 \text{ m}$

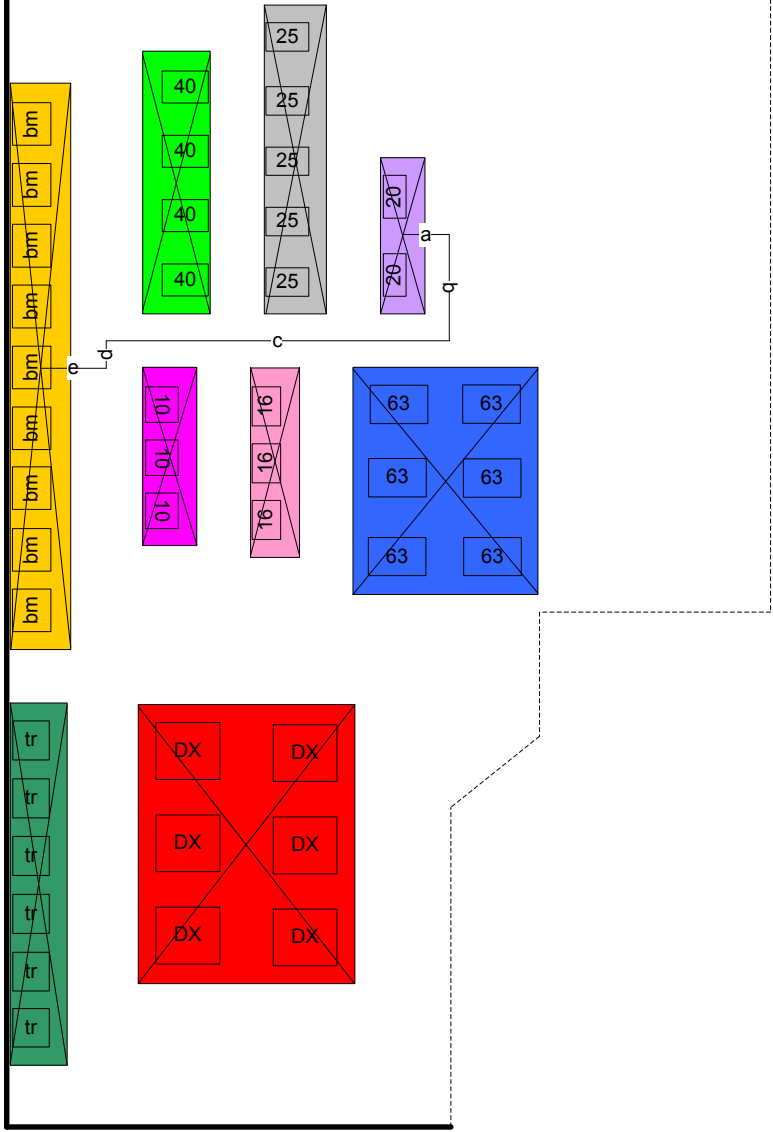

Jarak P 25 T – P 63 T
 $a+b+c+d = 13,304 \text{ m}$

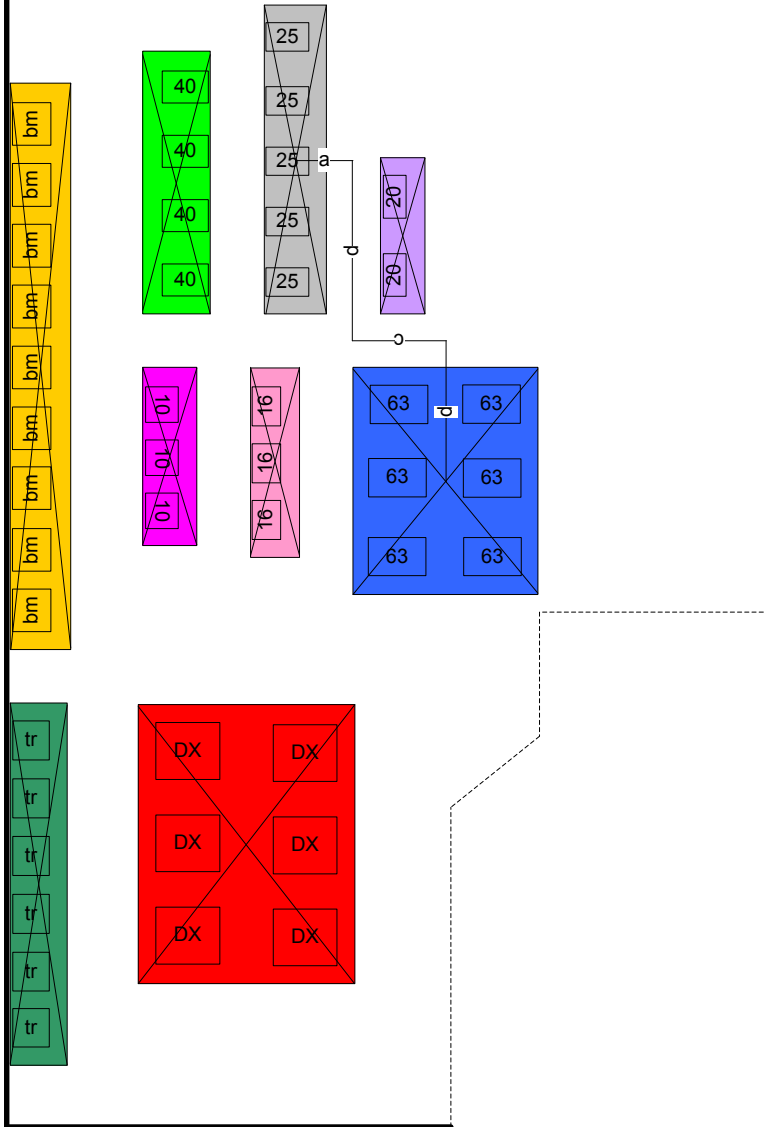

Jarak P 63 T – TR
 $a+b+c+d+e = 22,882 \text{ m}$

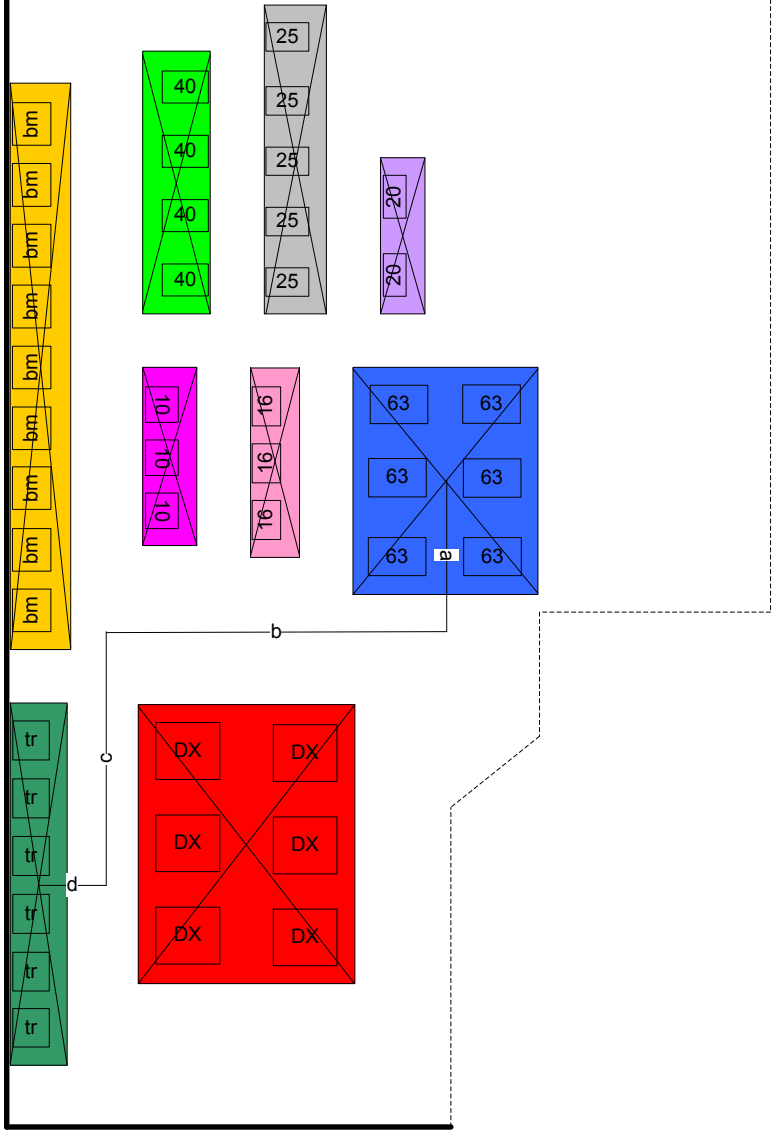

Jarak P 63 T – DX
 $a+b+c = 15,836 \text{ m}$

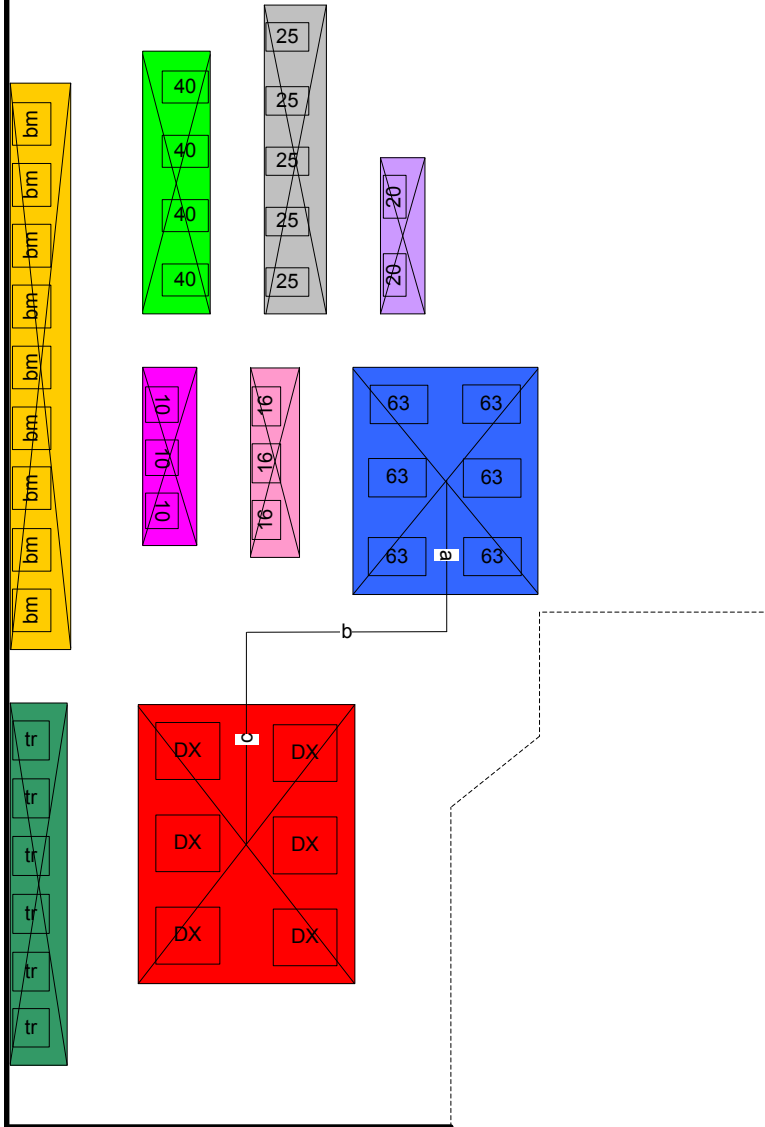

Jarak TR – P 25 T
 $a+b+c+d+e = 30,852 \text{ m}$

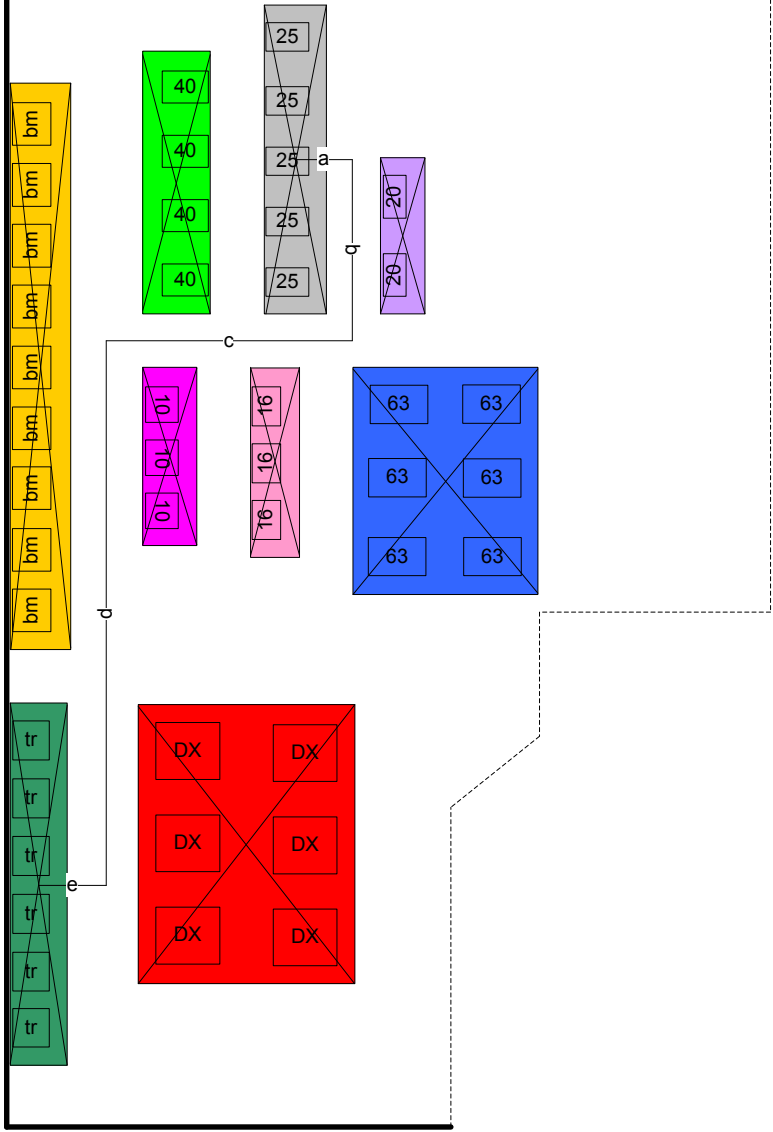

Jarak TR – P 25 T
 $a+b+c+d+e = 16,623 \text{ m}$

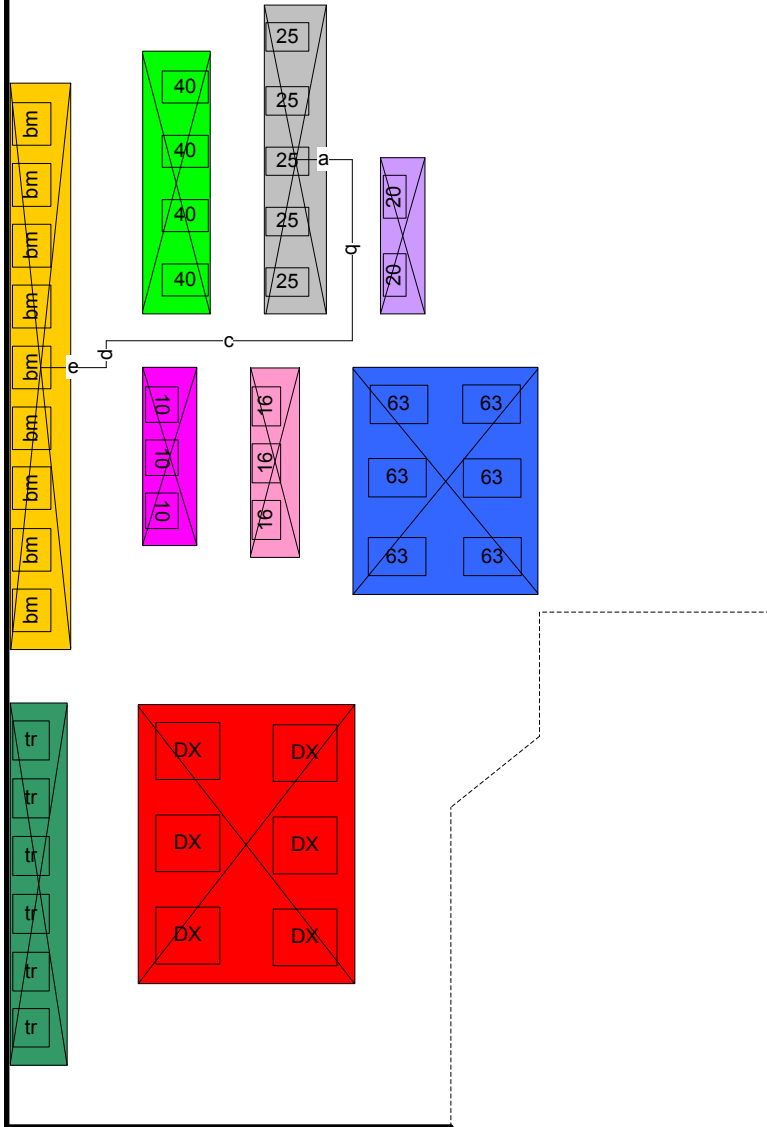

Jarak P 10 T – P 63 T
 $a+b+c+d = 15,039 \text{ m}$

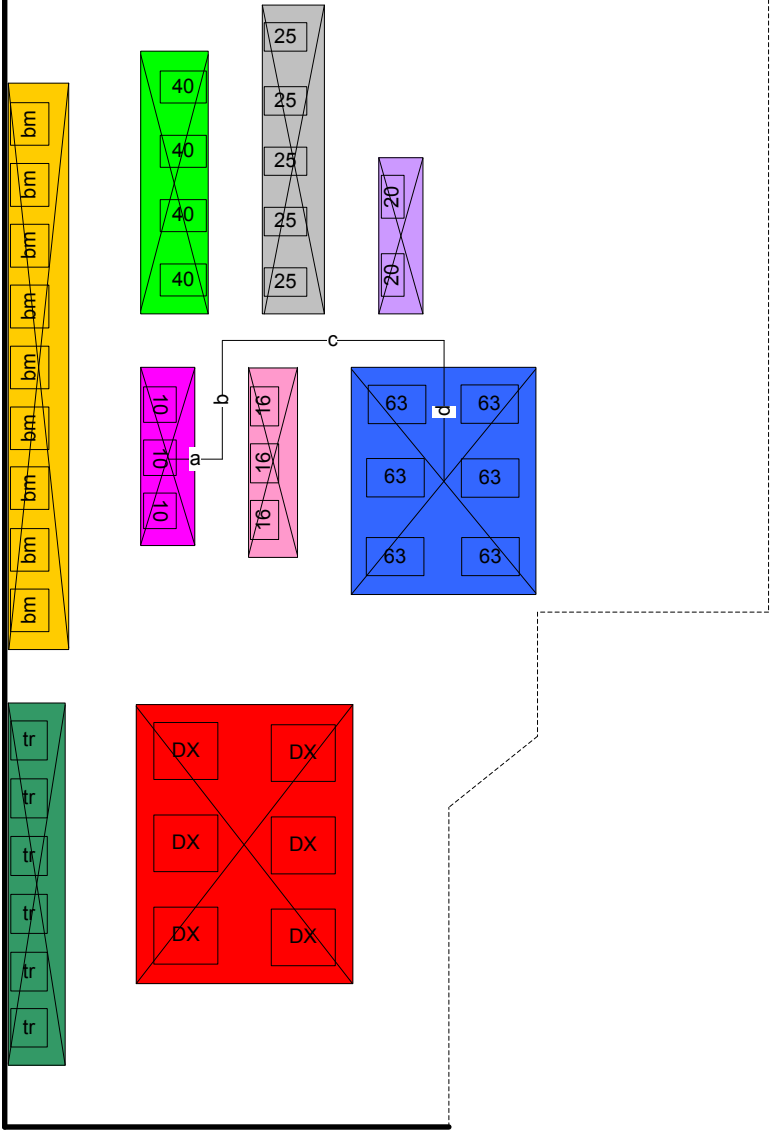

Jarak P 10 T – P 40 T
 $a+b+c = 10,586 \text{ m}$

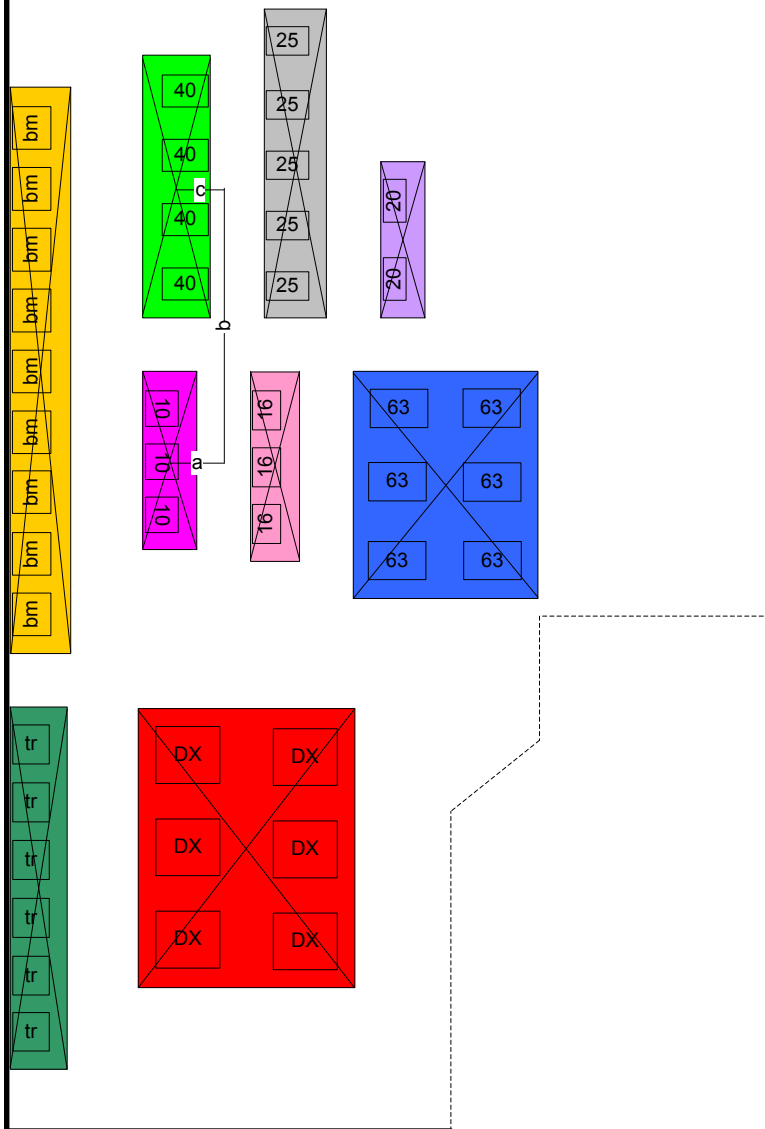

Jarak P 10 T – P 25 T
 $a+b+c+d+e = 15,03 \text{ m}$

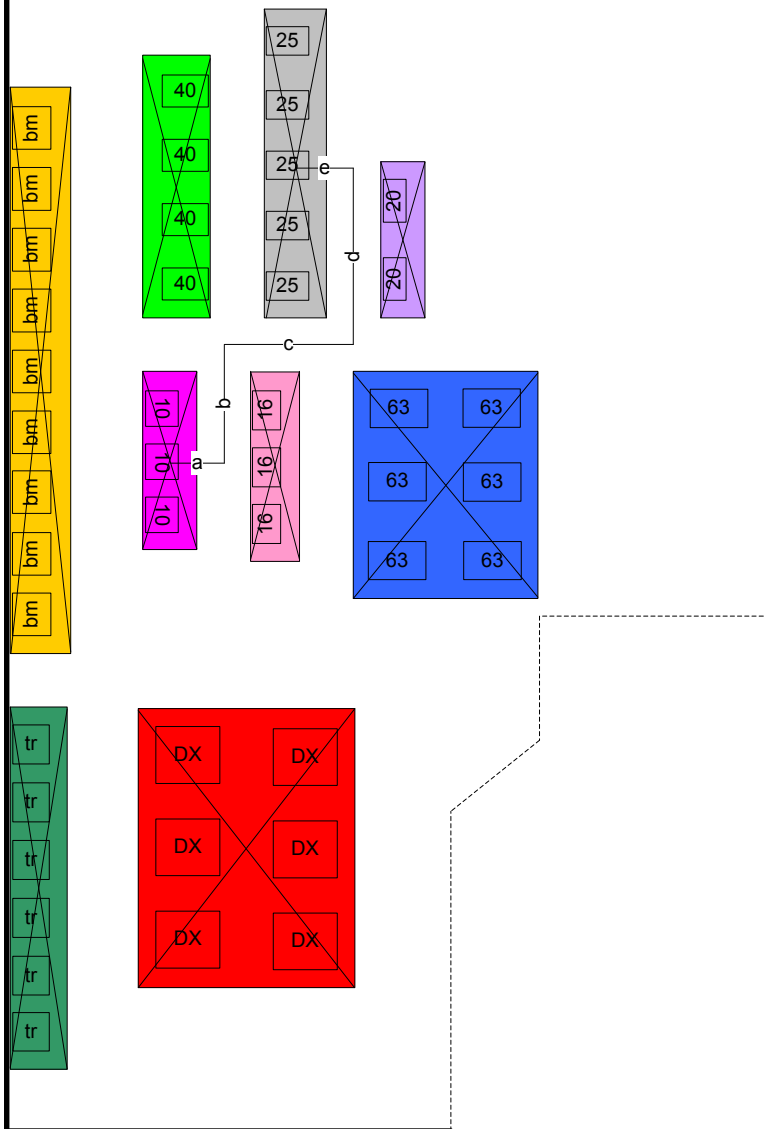

Jarak P 10 T – P 16 T
 $a+b+c+d+e = 12,604 \text{ m}$

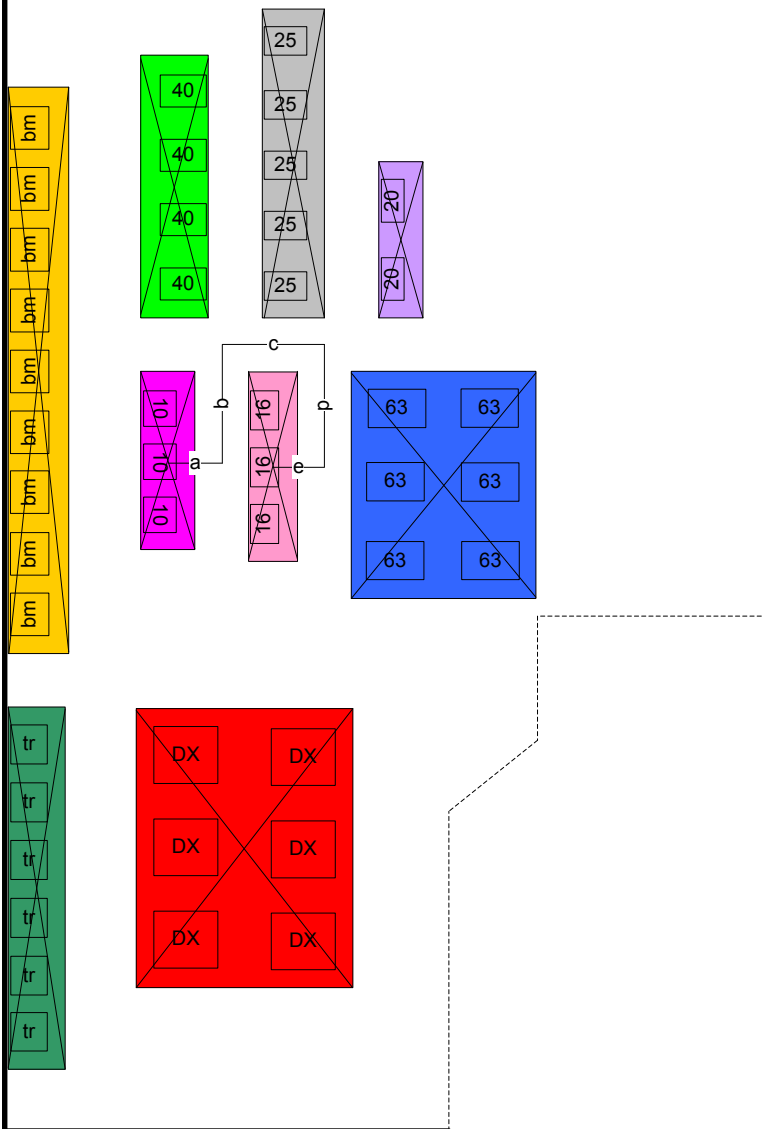

Jarak P 40 T – P 25 T
 $a+b+c+d+e = 15,729 \text{ m}$

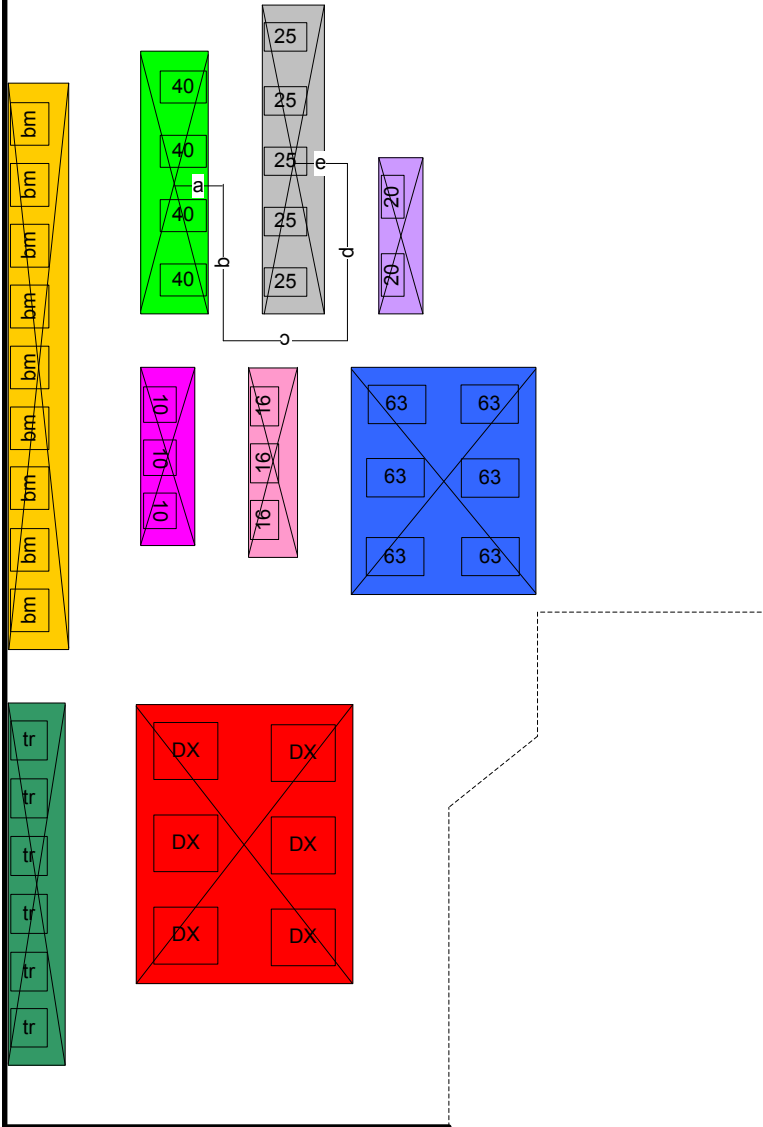

Jarak P 63 T – P 40 T
 $a+b+c+d+e = 15,91 \text{ m}$

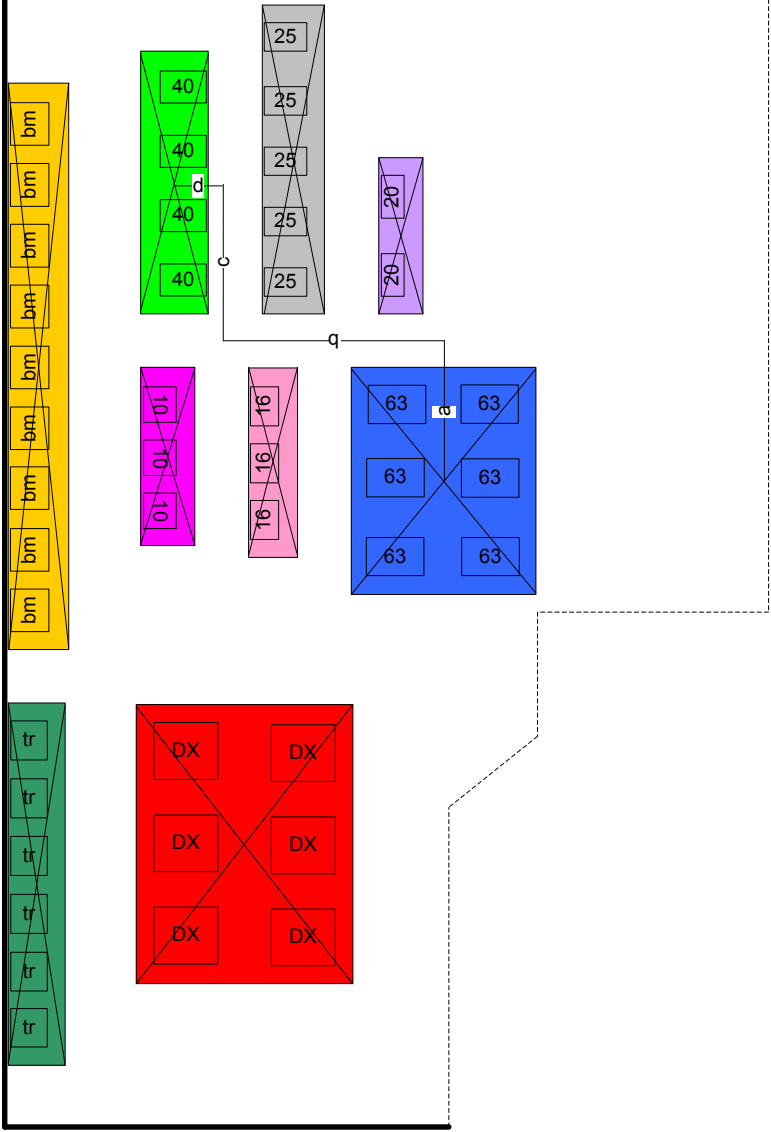

Jarak P 63 T – P 40 T
 $a+b+c+d+e = 15,91 \text{ m}$

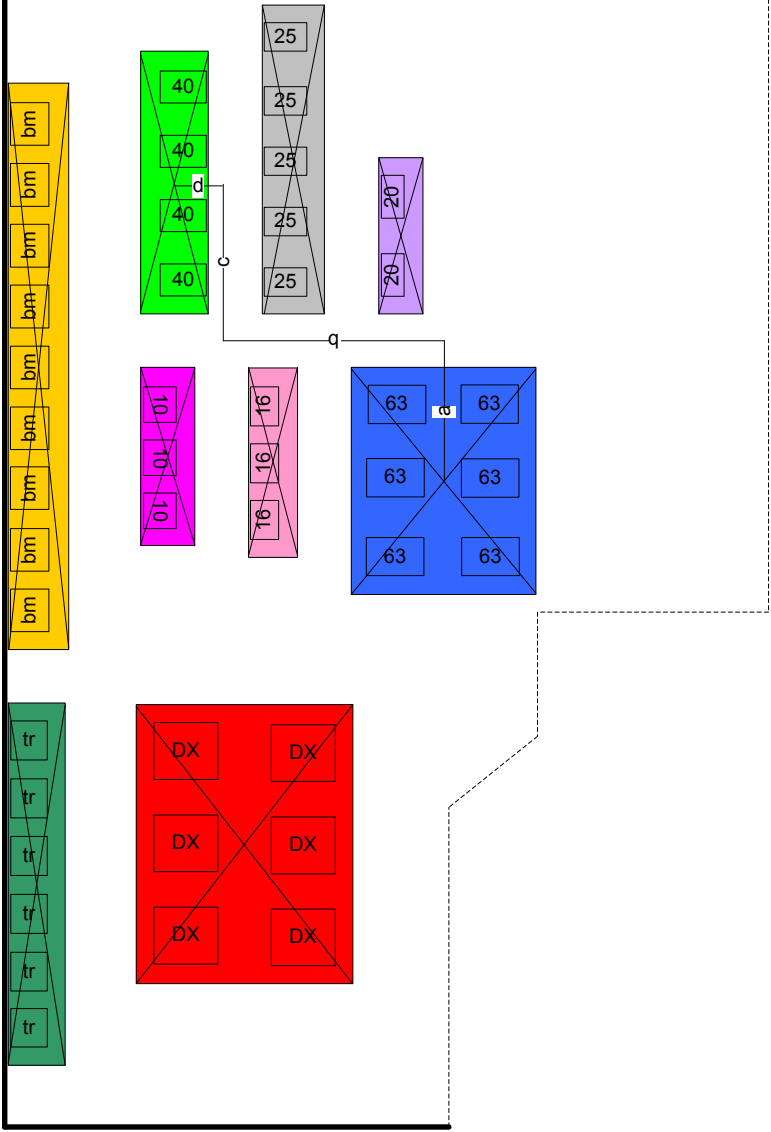

Jarak P 40 T – P DX
 $a+b+c+d = 20,523$ m

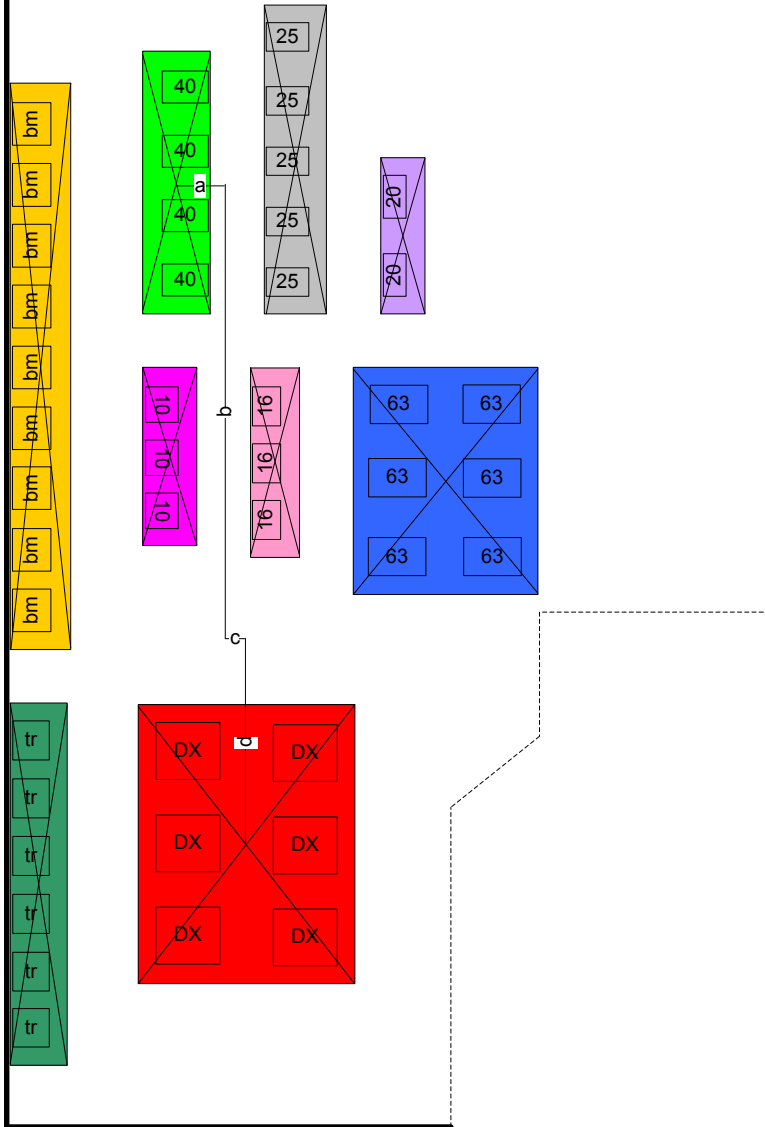

Jarak P 16 T – P DX
 $a+b+c+d+e = 14,456 \text{ m}$

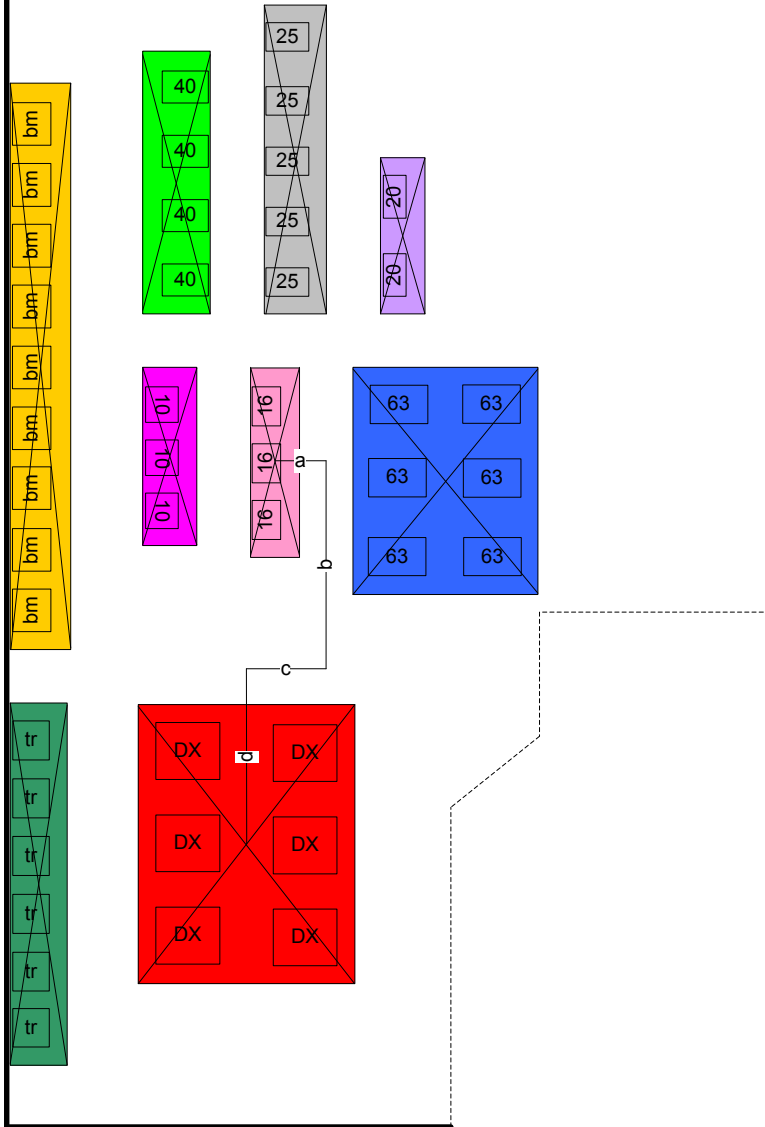

Jarak P 16 T – P 25
 $a+b+c+d+e = 12,234 \text{ m}$

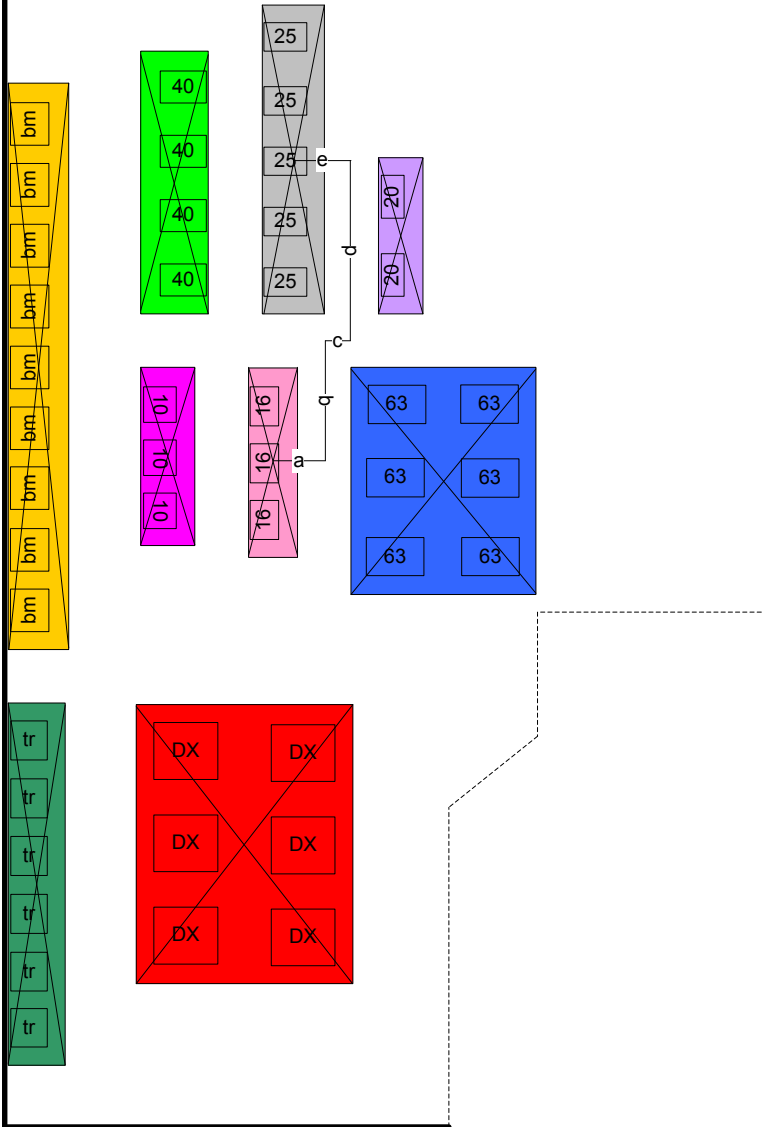

Jarak P 16 T – P 63 T
 $a+b+c+d = 12,055 \text{ m}$

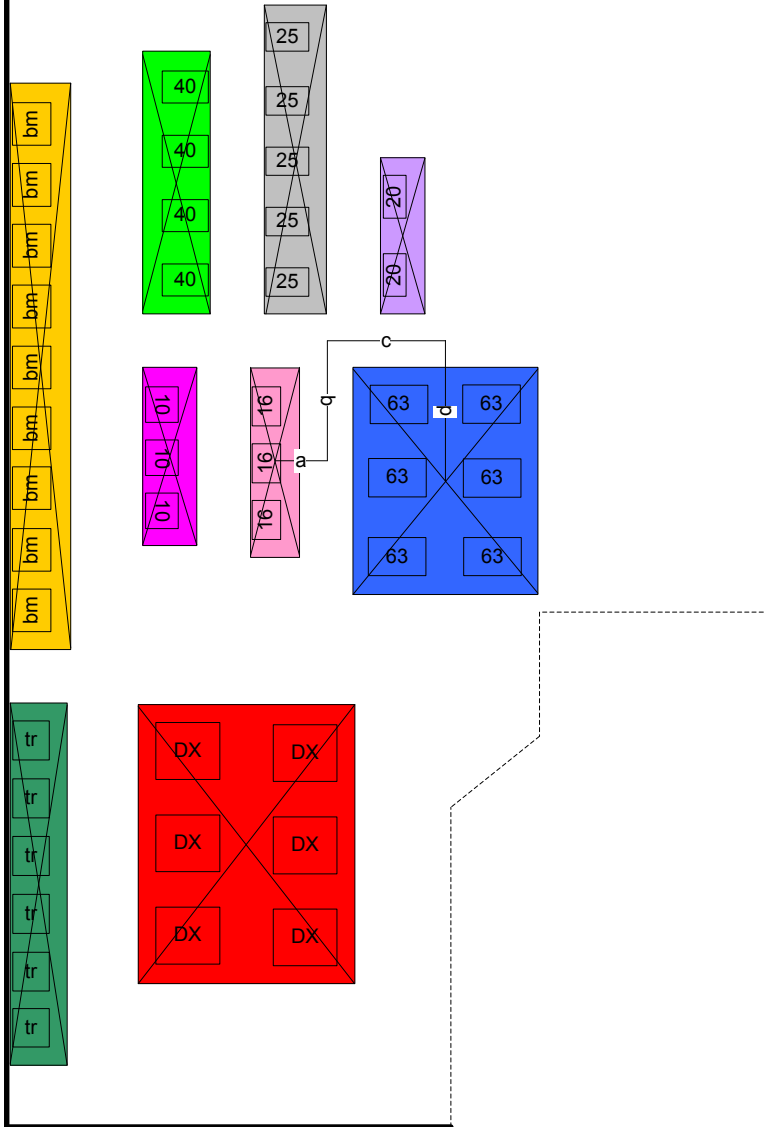

Jarak P DX – TR
 $a+b+c = 7,002 \text{ m}$

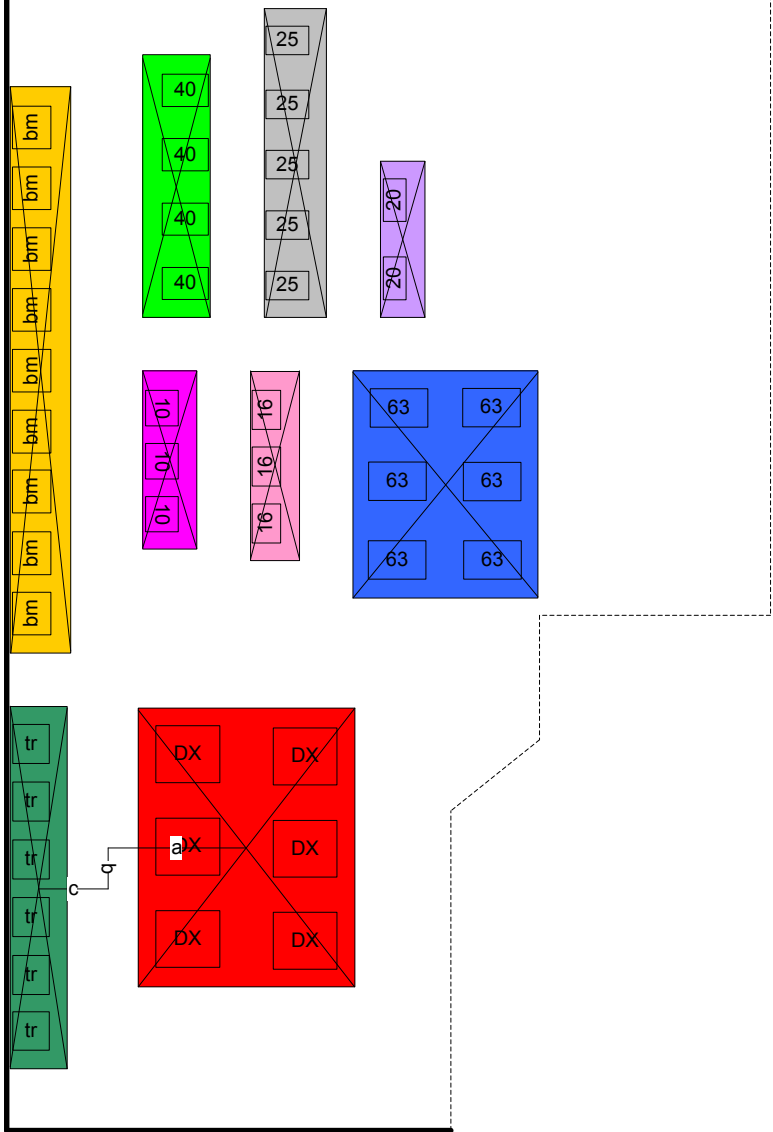

Jarak tata letak usulan

Jarak antara mesin sel 1

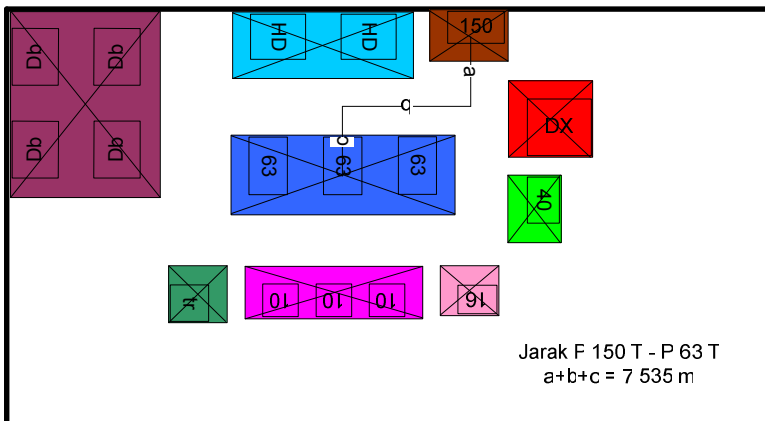
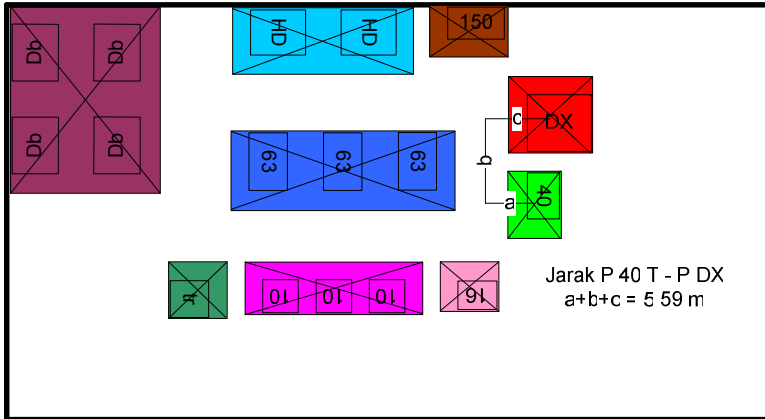
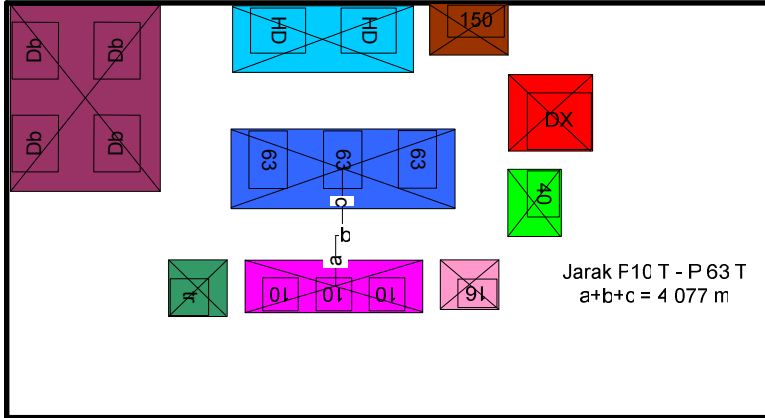

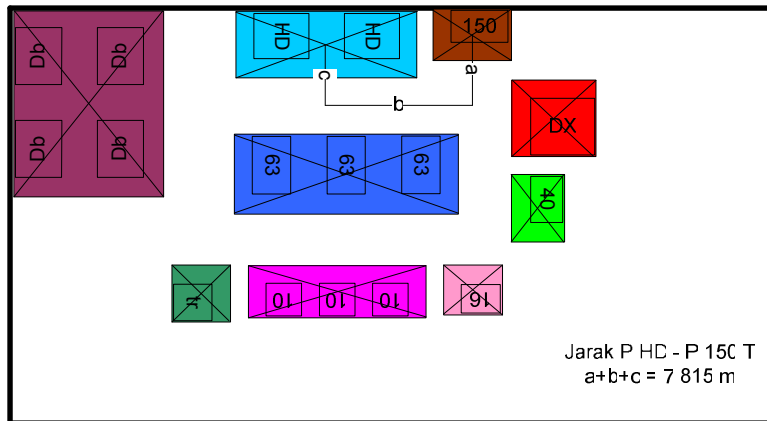
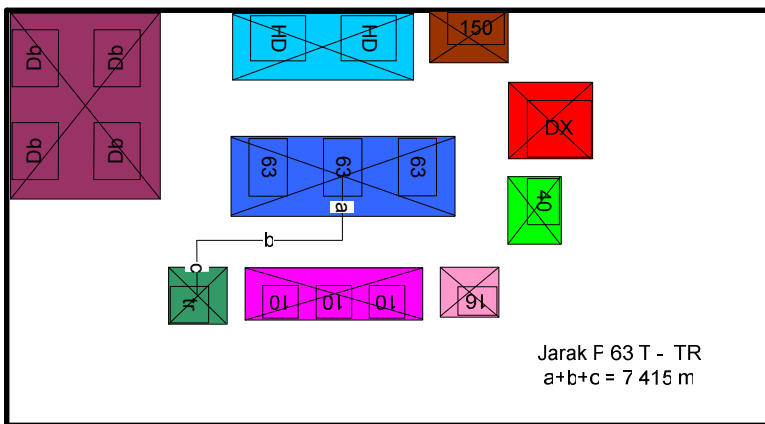
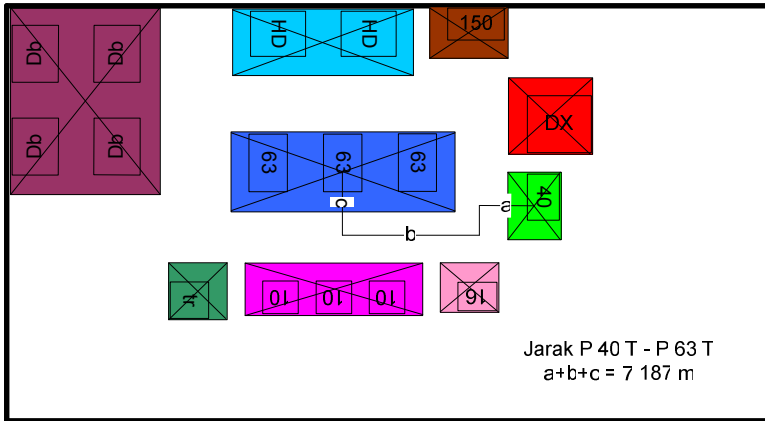

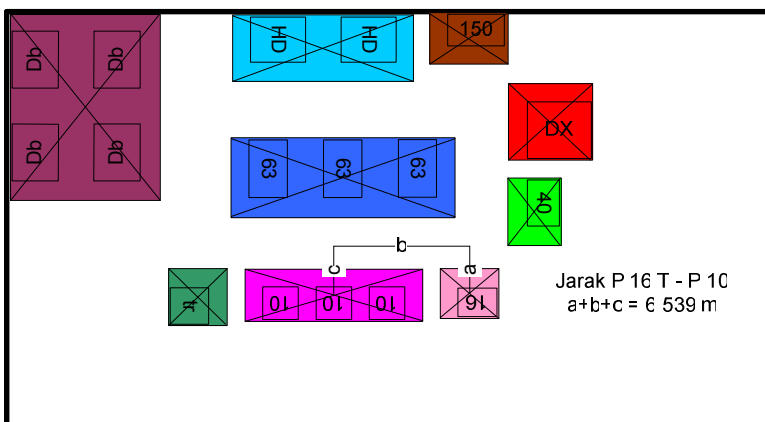
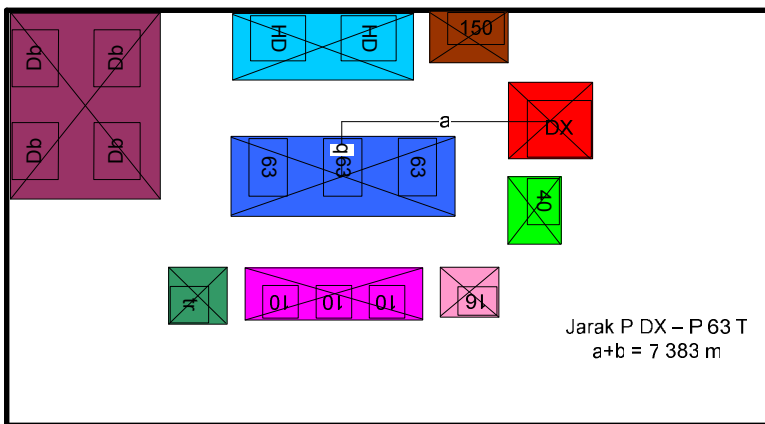
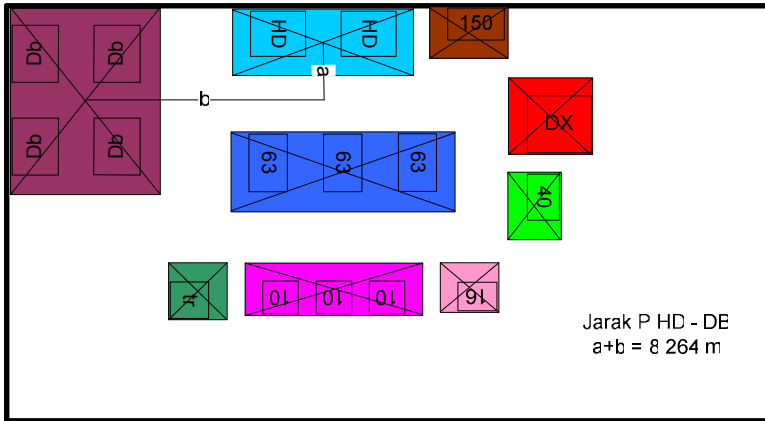

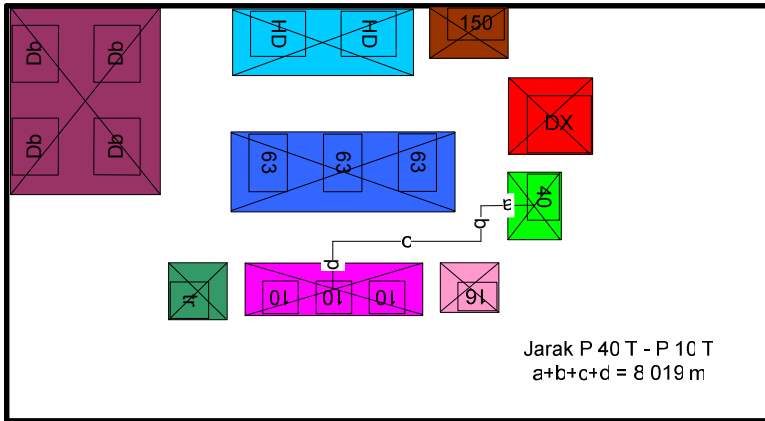

Jarak antara mesin sel 2

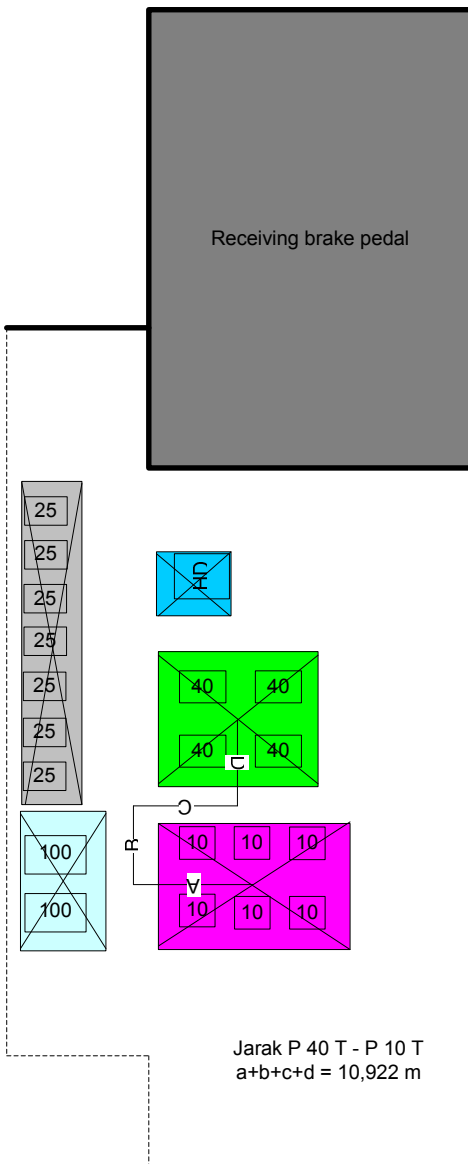

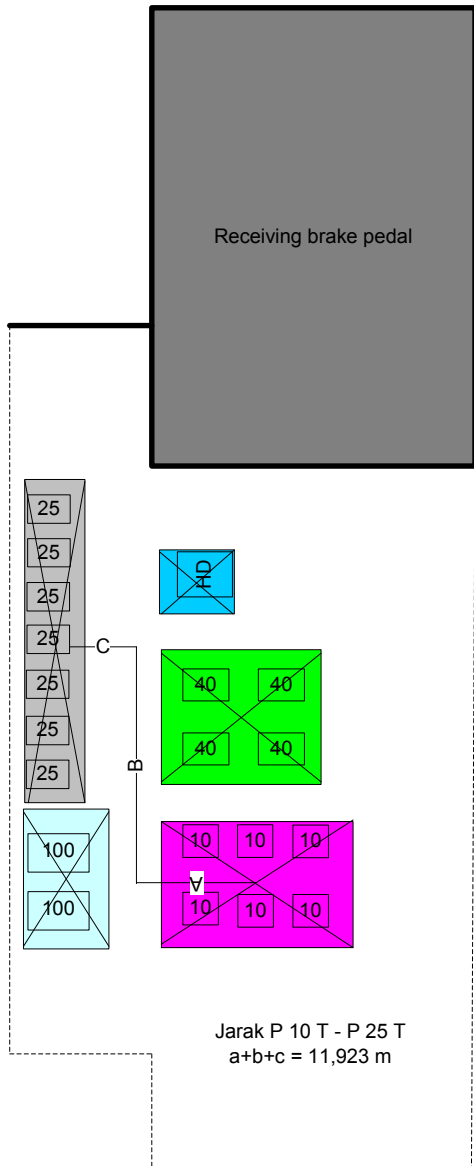

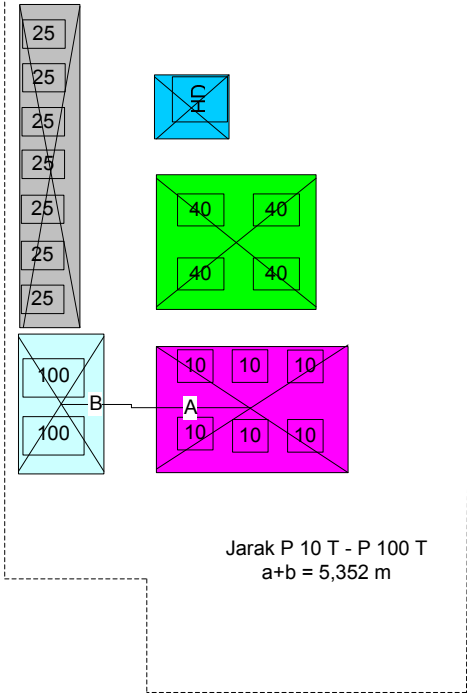
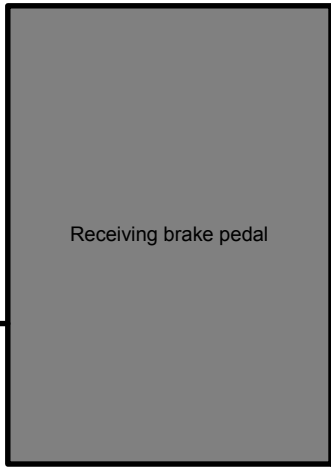

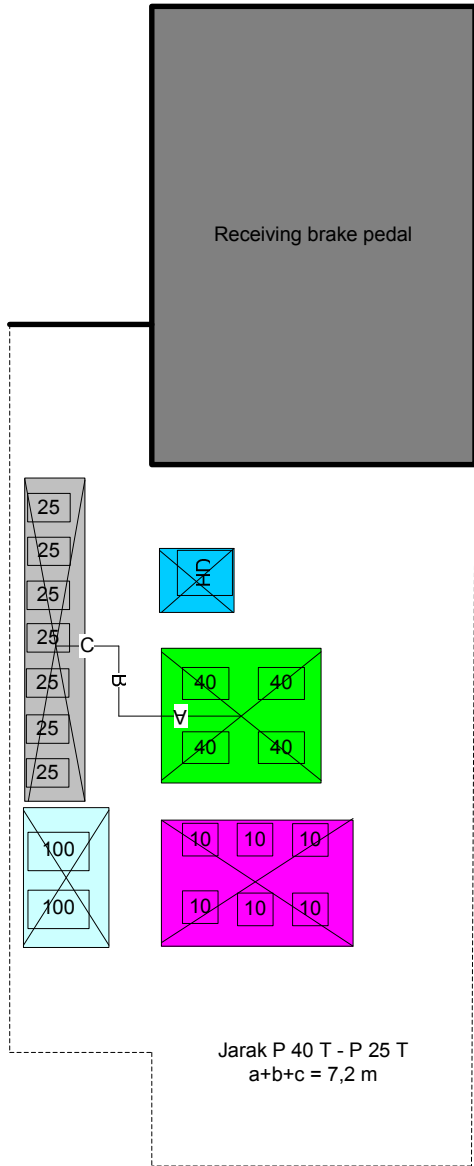

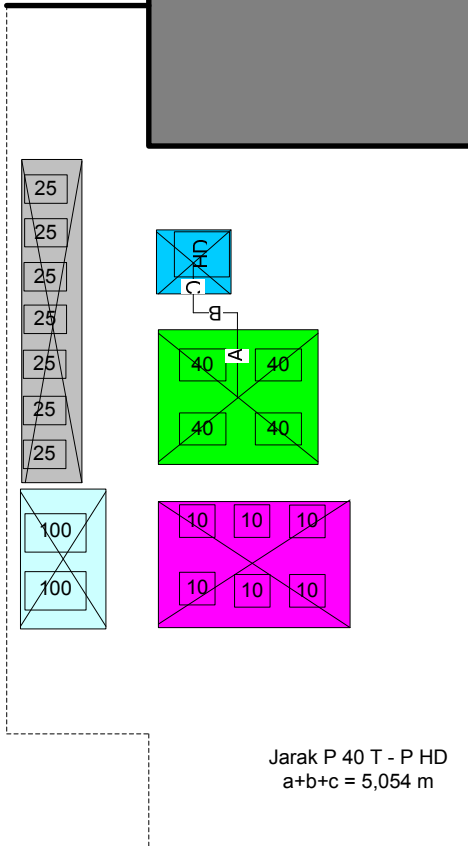
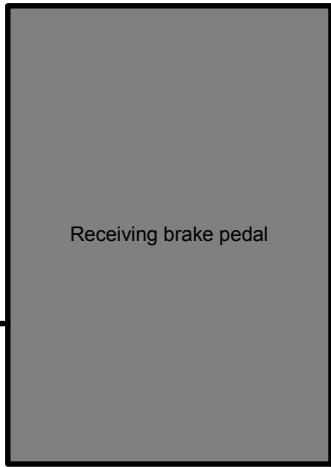

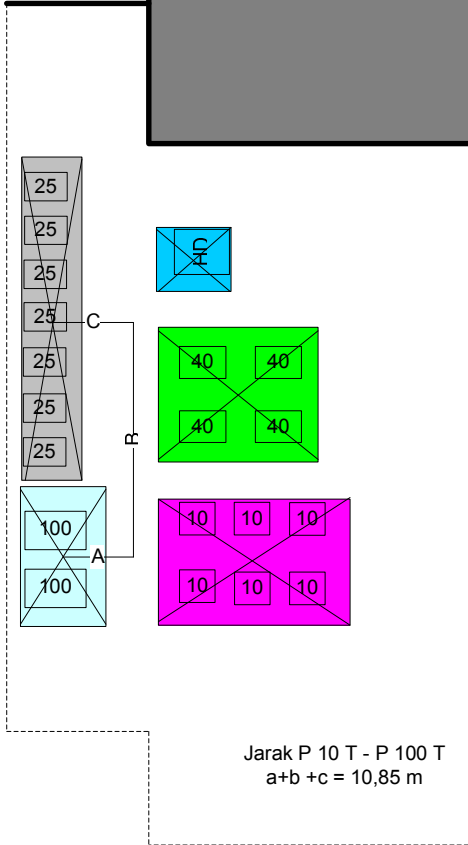
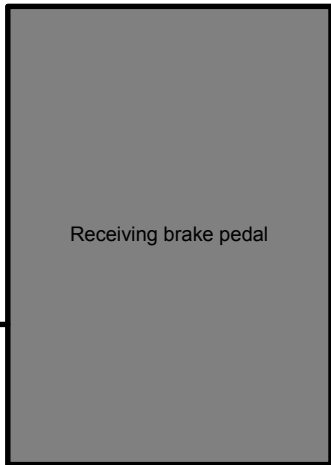

Jarak P 10 T - P 100 T
 $a+b+c = 10,85 \text{ m}$

Jarak antara mesin sel 3

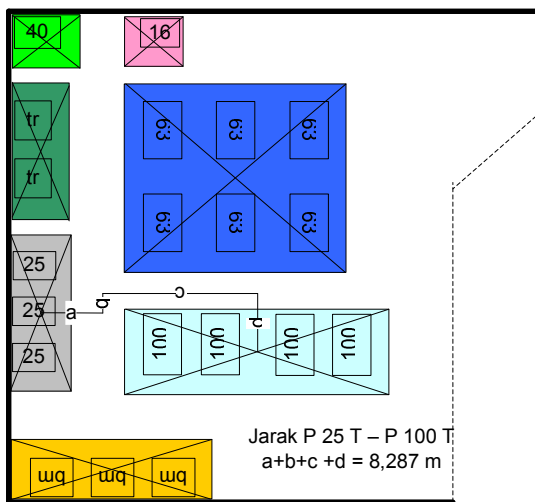
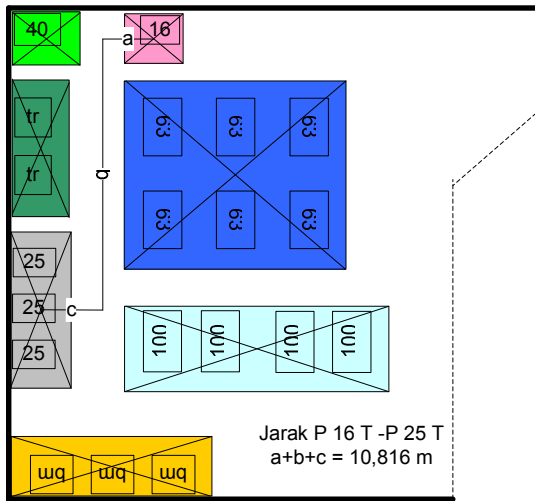
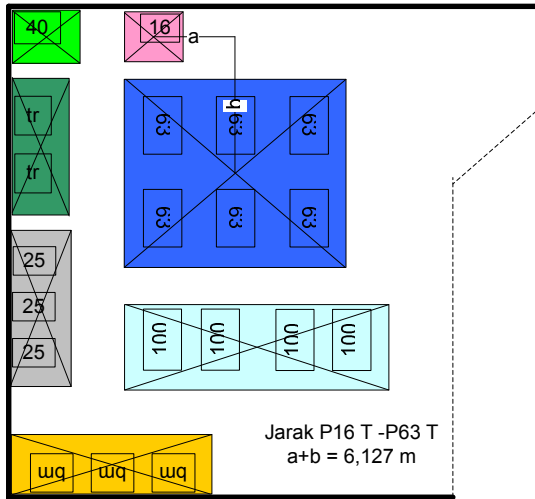

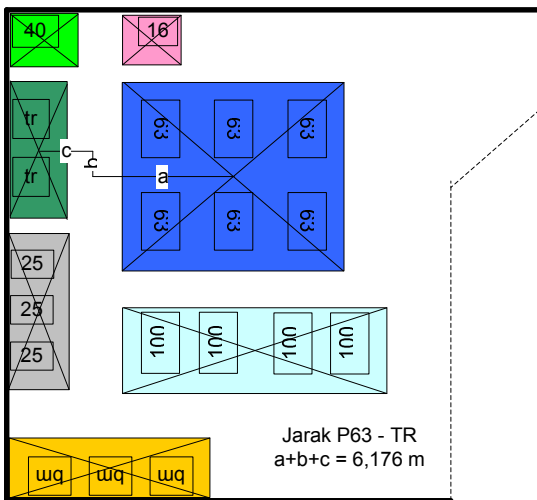
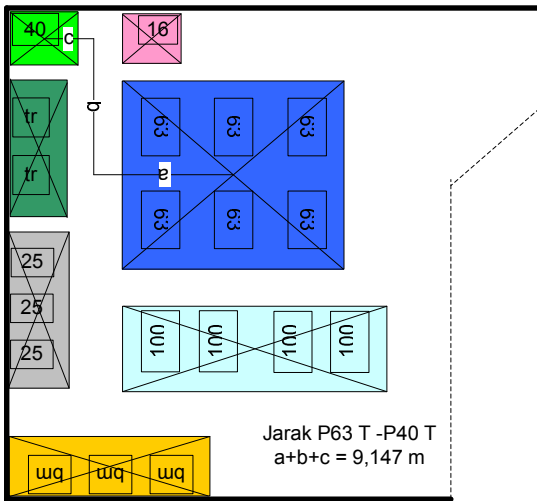
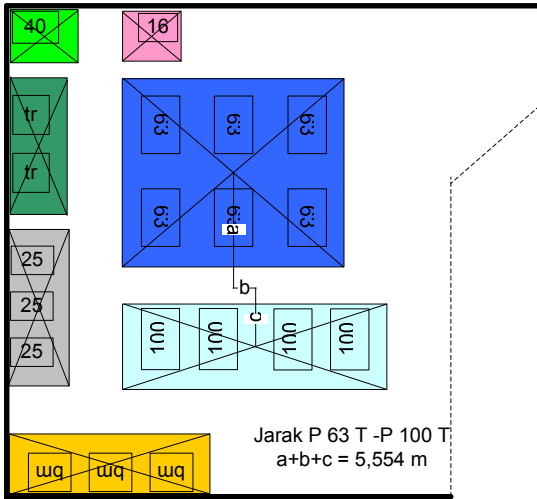

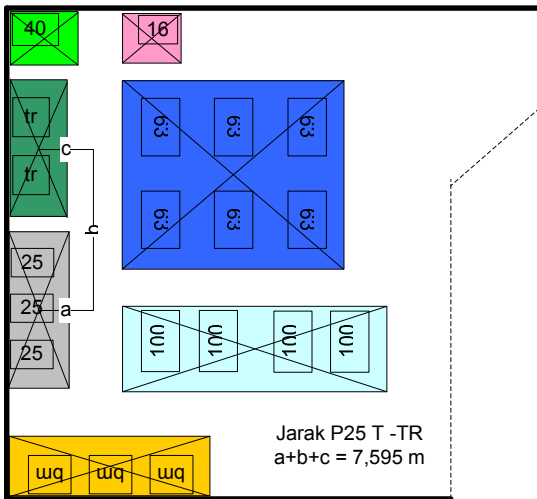
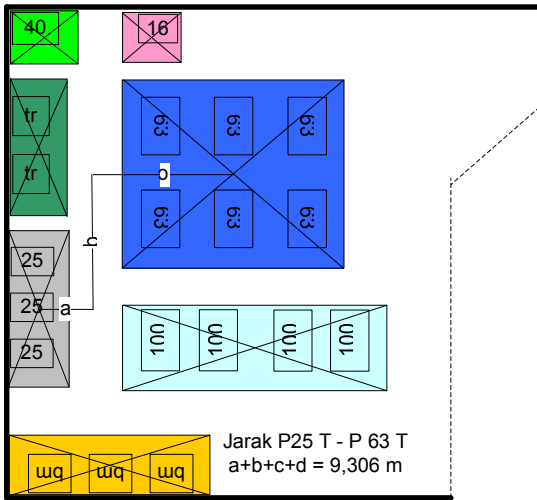
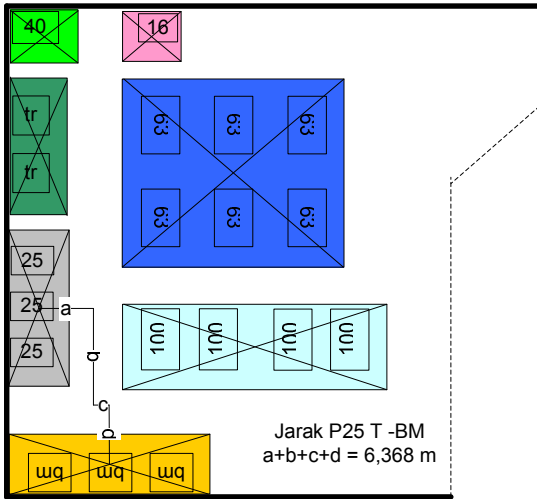

Jarak antara mesin sel 4

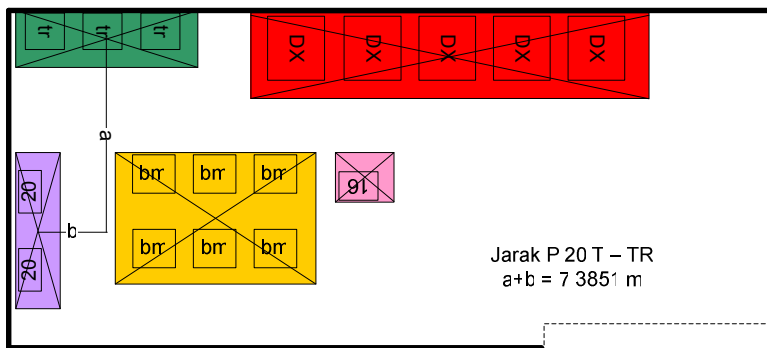
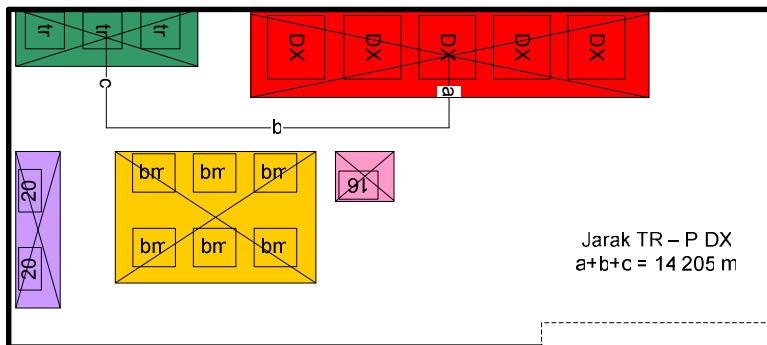
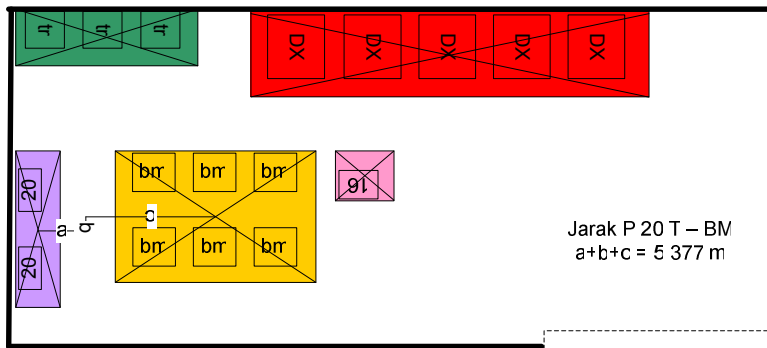
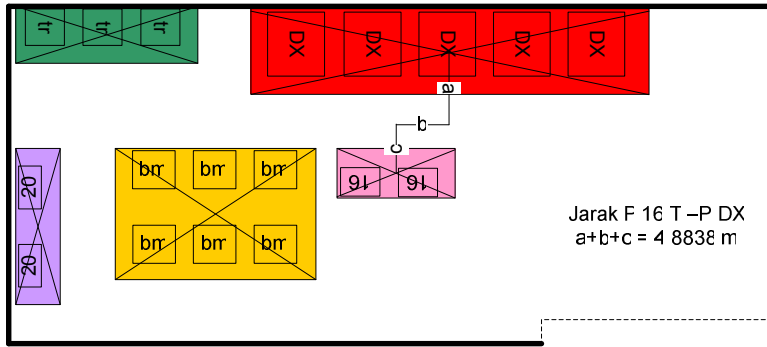

Jarak inter sel

