

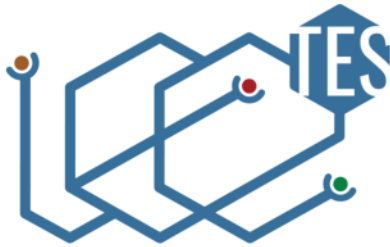

UNIVERSITAS
KRISTEN
MARANATHA



1ST INTERNATIONAL CONFERENCE
ON EMERGING ISSUES IN TECHNOLOGY,
ENGINEERING AND SCIENCE

PROCEEDINGS

1-2 JULY 2021

Editors

Jong Seong Kang

Hae Dong Jang

Lawrence Young

Viroj Boon

Emmanuel Jean-Francois

Ratnadewi

Papers available at



ICE-TES 2021

Proceedings of the
1st International Conference on
Emerging Issues in Technology, Engineering and
Science

Bandung - Indonesia

July 1 - 2, 2021

Copyright © 2022 by SCITEPRESS – Science and Technology Publications, Lda.
All rights reserved

Edited by Jong Seong Kang, Hae Dong Jang, Lawrence Young, Viroj Boon, Emmanuel Jean Francois and
Ratnadewi Ratnadewi

Printed in Portugal

ISBN: 978-989-758-601-9

DOI: 10.5220/0000147200003113

Depósito Legal: 504356/22

<https://event.maranatha.edu/icetes2021>

ice-tes2021@maranatha.edu

BRIEF CONTENTS

INVITED SPEAKERS	IV
ORGANIZING COMMITTEES	V
PROGRAM COMMITTEE	VII
FOREWORD	IX
CONTENTS	XI

INVITED SPEAKERS

Drs. Ignasius Jonan, M.A.

Former Minister for Energy & Mineral Resources of Indonesia
Indonesia

Prof. Dr. Ahmad M. Ramli, SH, MH, FCBArb

Faculty of Law, Padjadjaran University
Indonesia

Ikhsan Baidirus, SH., LLM.

Director of Post, General Directorate of Post and Information Technology, Ministry of Communication
and Informatics
Indonesia

Prof. John Hendry Silke

The Walter and Eliza Hall Institute
Australia

Prof. Takayuki Arai

Dept. of Information and Communication Sciences, Sophia University
Japan

Prof. Young Ho Kim Ph.D.

College of Pharmacy, Chungnam National University
Korea

drg. Ferry Sandra, Ph.D.

Faculty of Dentistry, Trisakti University
Indonesia

Prof. Susy Tjahjani

Faculty of Medicine, Maranatha Christian University
Indonesia

ORGANIZING COMMITTEES

STEERING COMMITTEE

Prof. Gudivada Sudarsanam, Sri Venkateswara University, India
Prof. Hae Dong Jang, Hannam University, Korea
Prof. Lawrence Young, University of Warwick, United Kingdom
Prof. Young Ho Kim, Chungnam National University, Korea
Prof. Sri Widiyantoro, Maranatha Christian University, Bandung Institute of Technology, Indonesia
Prof. Budi Hartanto Susilo, Maranatha Christian University, Indonesia
Prof. Marcellia Susan, Maranatha Christian University, Indonesia
Prof. Susy Tjahjani, Maranatha Christian University, Indonesia
Prof. Wilson Bangun, Maranatha Christian University, Indonesia

GENERAL CHAIR

Dr. Hapnes Toba, M.Sc., Maranatha Christian University, Indonesia

GENERAL CO-CHAIR

Dr. Wahjoe Widowati, M.Si., Maranatha Christian University, Indonesia

SECRETARIAT CHAIR

Dr. dr. Hana Ratnawati, M.Kes., Maranatha Christian University, Indonesia

FINANCE CHAIR

Dr. Teresa L. Wargasetia, S.Si, M.Kes., PA(K), Maranatha Christian University, Indonesia

SCIENTIFIC PROGRAM CHAIR

Dr. Ratnadewi, S.T., M.T., Maranatha Christian University, Indonesia

SCIENTIFIC PROGRAM MEMBERS

Dr. drg. Vinna Kurniawati Sugiaman, M.Kes., Maranatha Christian University, Indonesia
Andreas Widjaja, S.Si., M.Sc., Ph.D., Maranatha Christian University, Indonesia
Agustinus Oey, Ph.D., Lucky Goldstar (LG) Electronics, Korea
Alfredo Satyanaga Nio, Ph.D., Nanyang Technological University, Singapore

PUBLICITY & PUBLIC RELATION CHAIR

Iwan Santosa, S.T., Maranatha Christian University, Indonesia

EDITORS

Prof. Jong Seong Kang., Chungnam National University, Korea
Prof. Hae Dong Jang, Hannam University, Korea
Prof. Lawrence Young, University of Warwick, United Kingdom
Prof. Viroj Boon, Chulalongkorn University, Thailand
Dr. Emmanuel Jean-Francois, Ohio University, United States
Dr. Ratnadewi, S.T., M.T., Maranatha Christian University, Indonesia

CO-EDITORS

Dr. Hana Ratnawati, dr., M.Kes., Maranatha Christian University, Indonesia
Andreas Widjaja, S.Si., M.Sc., Ph.D., Maranatha Christian University, Indonesia
Dr. Hapnes Toba, M.Sc., Maranatha Christian University, Indonesia
Dr.drg. Vinna Kurniawati Sugiaman, M.Kes., Maranatha Christian University, Indonesia
Yenni M. Djajalaksana, S.E., M.B.A, Ph.D., Maranatha Christian University, Indonesia
Monica Hartanti, S.Sn., M.Ds., Maranatha Christian University, Indonesia
Daniel Hendrawan, S.H., M.Hum., M.Kn., Maranatha Christian University, Indonesia
Ida, S.E., M.M., Maranatha Christian University, Indonesia
Meily Margaretha, S.E., M.Ed., Maranatha Christian University, Indonesia

PROGRAM COMMITTEE

Agustinus Oey, Ph.D., Lucky Goldstar (LG) Electronics, Korea

Alfredo Satyanaga Nio, Ph.D., Nanyang Technological University, Singapore

Prof. Jong Seong Kang, Chungnam National University, Korea

Prof. Hae Dong Jang, Hannam University, Korea

Prof. Terutoshi Tada, Toyo University, Japan

Dr. Bambang Dwi Wijanarko, Binus University, Indonesia

drg. Ferry Sandra, Ph.D., Trisakti University, Indonesia

Dr. Bernard Renaldy Suteja, S.Kom., M.Kom., Maranatha Christian University, Indonesia

Dr. Ir. Christina Wirawan, M.T., Maranatha Christian University, Indonesia

Cindrawaty Lesmana, S.T., M.Sc.(Eng). Ph.D., Maranatha Christian University, Indonesia

Dr. dr. Diana Krisanti Jasaputra, M.Kes., Maranatha Christian University, Indonesia

Dr. Erwani Merry Sartika, S.T., M.T., Maranatha Christian University, Indonesia

Dr. Teresa Liliana Wargasetia, S.Si., M.Kes., PA(K), Maranatha Christian University, Indonesia

Dr. Hana Ratnawati, dr., M.Kes., Maranatha Christian University, Indonesia

Andreas Widjaja, S.Si., M.Sc., Ph.D., Maranatha Christian University, Indonesia

Dr.dr. Meilinah Hidayat, M.Kes., Maranatha Christian University, Indonesia

Dr. Yosafat Aji Pranata, S.T., M.T., Maranatha Christian University, Indonesia

Dr. Wahjoe Widowati, M.Si., Maranatha Christian University, Indonesia

drg. Dahlia, Sp.Pros., Maranatha Christian University, Indonesia

Dr.dr. Julia Windi Gunadi, M.Kes., Maranatha Christian University, Indonesia

Robby Yussac Tallar, S.T., M.T., Dipl.IWRM., Ph.D., Maranatha Christian University, Indonesia

Dr. Hapnes Toba, M.Sc., Maranatha Christian University, Indonesia

Dr.drg. Vinna Kurniawati Sugiaman, M.Kes., Maranatha Christian University, Indonesia

Dr. Ratnadewi, S.T., M.T., Maranatha Christian University, Indonesia

Marvin Chandra Wijaya, S.T., M.M., M.T., Maranatha Christian University, Indonesia

Semuil Tjiharjadi, S.T., M.M., M.T., Maranatha Christian University, Indonesia

drg. Angela Evelynna, M.Kes., Maranatha Christian University, Indonesia

Dr. Riko Arlando Saragih, S.T., M.T., Maranatha Christian University, Indonesia

FOREWORD

Message from the Rector



Honorable Keynote Speaker, Mr. Ignasius Jonan, former Minister of the Energy and Mineral Resources, and previously Minister of the Transportation Ministry of the Republic of Indonesia, we are greatly honored to have you with us this morning.

Distinguished keynote speakers, Prof. Ahmad M. Ramli (represented by Ikhsan Baidirus, S.H., LL.M., Director of Post, General Directorate of Post and Information Technology, Ministry of Communication and Information Technology), Prof. John Silke, Dr. Ferry Sandra, Prof. Takayuki Arai, Prof. Young Ho Kim, Prof. Susy Tjahjani, Prof. Pim Martens, Dr. Dwinita Larasati, Prof. Chien-Hsu Chen, Prof. Wilson Bangun and Prof. Marcellia Susan, as well as all participants in the international conferences at Maranatha University.

A very good morning and best wishes to you all, and good evening to our colleagues in the US. Greetings and a warm welcome to Maranatha Christian University (MCU), Bandung, Indonesia.

I am delighted to be here with you today for the opening of the first MCU international conferences. These are: (i) The International Conference on Emerging Issues in Technology, Engineering, and Science, and (ii) The International Conference on Emerging Issues in Humanity Studies and Social Sciences, with the themes of: Digital Ecosystems for Sustainable Health and Community Development towards an Intelligent Society, and Innovations for Sustainable Community Development - Research and Practices, respectively.

We thank the many participants from countries across the different continents: the USA, the UK, the Netherlands, Norway, Taiwan, Japan, Korea, Thailand, Singapore, Malaysia, India, Australia, and New Zealand.

These first international conferences will serve as a platform to enable speakers and participants to share their research results, drawn from up-to-date research work, to initiate and strengthen further collaboration.

Without further ado, I would like to thank all the participants who have joined us for these international conferences. Again, my sincere hope is that what we accomplish today will be beneficial towards establishing collaboration among all the participants of these conferences.

I hereby declare the first international conferences at MCU in 2021 officially open.

May God bless you all. Thank you.

Prof. Ir. Sri Widiyantoro, MSc., PhD., IPU.
Rector of Maranatha Christian University

Foreword



On behalf of the committee members, it is a great pleasure to welcome you all to our first two international conferences: Emerging Issues in Technology, Engineering, and Science (ICE-TES) and, Emerging Issues in Humanity Studies and Social Sciences (ICE-HUMS).

ICE-TES and ICE-HUMS are twin events which serve our passion in balancing technology and humanity issues in the world of science and share the core values of our university: Integrity, Care & Excellence (ICE).

This year's theme for both conferences focus on the United Nations' Sustainable Development Goals (SGD), which emphasize the following aspects: ICE-TES (Digital Ecosystem for Sustainable Health & Community Development: Towards the Intelligent Society) and ICE-HUMS (Innovations for Sustainable Community Development: Research and Practices). We believe research and initiatives that has pragmatic and multidisciplinary/interdisciplinary approaches allows us to unravel fundamental problems and answer related questions regarding sustainable development.

The logistics of both of the First ICE-TES and ICE-HUMS 2021 conferences consist of two general and five-scientific keynote speakers. Special tracks are designed in each conference which cover recent developments in: ICE-TES (technologies, engineering, medical, and dentistry), ICE-HUMS (psychology, languages & cultures, economics, arts & design, and laws). The ICE-TES tracks received 82 submissions and 51 are accepted in the proceedings, involving authors from five countries, and corresponding to an acceptance rate of 62.2%. At the same time, the ICE-HUMS has received 130 submissions and 73 are accepted in the proceedings, involving authors from four countries, corresponding to an acceptance rate of 56.1%. All submitted papers were peer-reviewed on the basis of their significance, state-of-the-art contributions, and technical qualities.

Since we are still in the midst of COVID-19 pandemic, the conference has been organized virtually. The organizing committee has been working intensively to ensure that the scientific sessions will be valuable and engaging for all presenters and attendees. The parallel session format is a mix of pre-recorded and synchronous engagement through in-person live videos and question and answer sessions.

We would like to express our sincere appreciation to all the keynote speakers, committee members and reviewers for their dedication. Last, but certainly not least, we would like to offer many thanks to all authors who submitted their papers and all participants who registered to join this conference. We believe that ICE-TES and ICE-HUMS 2021 will be an inspiring academic occasion and will become a great platform for many ideas as well as research initiatives in the scientific community. Have an inspiring conference!

Dr. Hapnes Toba, M.Sc., General Chair of ICE-TES and ICE-HUMS 2021

Dr. Wahjoe Widowati, M.Si., General Co-chair of ICE-TES 2021

Joni, Ph.D., Ak., CA., CPSAK., General Co-chair of ICE-HUMS 2021

CONTENTS

PAPERS

FULL PAPERS

- What Is a Speech Chain and How Can This Concept Be Applied to the Various Areas of Speech Communication in an Intelligent Society? 5
Takayuki Arai
- Exploration of an Indonesian Currency Legality Detection System by Utilizing Image Intensity of RGB Mean Values 9
Ratnadewi Ratnadewi, Aan Darmawan Hangkawidjaja, Agus Prijono, Rudy Wawolumaja, Kartika Suhada, Maria Christine Sutandi, Andrew Sebastian Lehman, Elty Sarvia and Kervin Lusiano
- Comparative Study of Convolutional Neural Networks-based Algorithm for Fine-grained Car Recognition 18
Joseph Sanjaya, Mewati Ayub and Hapnes Toba
- Estimation of Paddy Leaf Nitrogen Status using a Single Sensor Multispectral Camera 26
Muliady Muliady, Tien Sze Lim, Voon Chet Koo and Nathaniel Pius Winata
- Taekwondo Poomsae-3 Movement Identification by using CNN 32
Novie Theresia Br. Pasaribu, Erwani Merry, Kalya Icasia, Jordan Eliezer, Che-Wei Lin and Febryan Setiawan
- Design and Implementation of a Path Finding Robot using Modified Trémaux Algorithm 39
Semuil Tjiharjadi
- Priority Petri Net Multimedia Model for Non-deterministic Events of Multimedia Presentations 49
Marvin Chandra Wijaya
- Anti-inflammatory Activities of Pineapple (*Ananas comosus*) Core Extract in Lipopolysaccharide-induced RAW264.7 Cell Line 58
Hanna Sari Widya Kusuma, Hartini Tiono, Philips Onggowidjaja, Selonan Susang Obeng, Wahyu Widowati, Cintani Dewi Wahyuni, Cahyaning Riski Wijayanti, Muhamad Aldi Maulana, Tri Handayani and Rizal Rizal
- Potential of Black Tea (*Camellia Sinensis* (L.) O. Kuntze) Extract as Anti-oxidant and Skin Anti-aging 65
Wahyu Widowati, Rita Tjokropranoto, Cindy Damayanti, Hanna Sari Widya Kusuma, Tri Handayani and Rizal Rizal
- Luteolin Possess Anti-inflammatory Effect on LPS Induced RAW 264,7 Cell Lines 74
Ervi Afifah, Hartini Tiono, Philips Onggowidjaja, Selonan Susang Obeng, Wahyu Widowati, Cintani Dewi Wahyuni, Cahyaning Riski Wijayanti, Muhammad Aldi Maulana, Tri Handayani and Rizal Rizal
- The Effect of Different Intensities of Treadmill Exercise on FGF23 Gene Expression in Gastrocnemius and Soleus Muscles of Wistar Rats 81
Julia Windi Gunadi, Diana Krisanti Jasaputra, Decky Gunawan, Ludovicus Edwinanto, Limdawati Kwee, Harijadi Pramono, Adrian Suhendra, Ghita Sariwidyantry, Hanna Goenawan and Ronny Lesmana

Antioxidant Properties of <i>Salacca zalacca</i> (Gaertn.) Voss Peel Ethanolic Extract Compared to Chlorogenic Acid <i>Ermi Girsang, Chrismis Novalinda Ginting, I Nyoman Ehrich Lister, Cahyaning Riski Wijayanti, Wahyu Widowati and Rizal Rizal</i>	87
Analyse Protein Model of the SARS-CoV-2 Virus using Data Mining Methods <i>Tiur Gantini and Hans Christian</i>	95
Antioxidant Properties of <i>Curcuma longa</i> L. and <i>Curcuma xanthorrhiza</i> Rhizomes <i>Dian Ratih Laksmiawati, Diah Kartika Pratami, Wahyu Widowati, Hanna Sari Widya Kusuma, Cahyaning Riski Wijayanti, Cintani Dewi Wahyuni, Ervi Afifah and Rizal Rizal</i>	104
The Effect of Agarwood Leaves Ethanol Extract on <i>Porphyromonas gingivalis</i> Growth Inhibition and in Vitro Cytotoxicity Assay on Fibroblast <i>Vinna Kurniawati Sugiaman, Henry Yonatan Mandalas, Ethan Yeshael Tanamal, Nathalia Cahya Calista and Natallia Pranata</i>	112
Comparison of Two Dental Age Estimation Methods: The London Atlas and the Schour & Massler Atlas in 3-23 Years Old Indonesian <i>Aprianisa Obsidiany Daisy Tarigan, Hendra Polii and Rosalina Intan Saputri</i>	122
The Effect of Apple Vinegar as an Irrigation Solution to Dental Root Canal Microstructure <i>Rudy Djuanda, Eliza Madyanty, Almira Anggarini Witjaksono, Vinna Kurniawati Sugiaman and Natallia Pranata</i>	126
The Color Dissimilarity based Method among Other Segmentation Methods: A Comparison <i>I Gede Made Karma, I Ketut Gede Darma Putra, Made Sudarma and Linawati</i>	131
Safety Driving Behaviour of Adolescents Pre-owning Driving License (SIM) <i>Sodikin and Hendramawat Aski Safarizki</i>	142
Virtual Reality Stimulants of Motor Ability through the Virtual Reality-based Game <i>Erwani Merry Sartika, Novie Theresia Br. Pasaribu, Richard Setiawan, Reynaldy Felicius Gunawan, Dion Melvern Siswanto, Che-Wei Lin and Febryan Setiawan</i>	146
Design of Bilateral Hand Movement Device using Design Thinking and Quality Function Deployment to Increase the Motoric Function of the Non-Dominant Hand <i>Novie Theresia Br. Pasaribu, Vivi Arisandhy, Christina, Elty Sarvia, Rainisa Maini Heryanto, Erwani Merry Sartika, Audyati Gany, Olga Catherina Pattipawaej, Richard Setiawan and Jessica</i>	153
Experimental Design of Driving with Distractions at Urban Area using Simulator Driving <i>Winda Halim, Rainisa Maini Heryanto, Santoso, Christina, Erwani Merry Sartika, Audyati Gany, Andrew Sebastian Lehman, Anggie Ervany Haryono and Vieri Candhya Wigayha</i>	159
Experimental Study on Velocity Profiles Due to Ecological Barriers <i>Robby Yussac Tallar and Teofilus Sawang</i>	167
Experimental Study on Riprap Layer Design for Circular Bridge Pier <i>Efferiki, Robby Yussac Tallar and Alexander Yovan Suwono</i>	172
Comparative Study of Riprap Model Design for Scour Protection of Bridge Pier <i>Cut Talitha Salsabila Nurapriili, Robby Yussac Tallar and Alexander Yovan Suwono</i>	176
The Experimental Study of Optimum Thickness on Riprap Layer Design <i>Dea Lidya, Robby Yussac Tallar and Alexander Yovan Suwono</i>	180











The Effect of Seismic Masses in Calculation of a 17 Multi-story Concrete Structure <i>Daud Rahmat Wiyono, Roi Milyardi, Yosafat Aji Pranata and Robby Y. Tallar</i>	184
Identification of Risk Factors for Delayed Time Schedule in Summarecon Serpong Playfield Preschool Project <i>Deni Setiawan and Stefanny Abigail</i>	190
Flood Risk Assessment of Heritage Building in Semarang City <i>Roi Milyardi, Deni Setiawan and Tri Octaviani Sihombing</i>	200
Identification of Risks in Making Decision for Overseas Expansion by Indonesian State-owned Construction Enterprise <i>Jeffrey Limas Lim, Ayomi Dita Rarasati and Mohammad Ichsan</i>	206
Pull-out Resistance of Glued-in Rod Embedded Parallel to Grain in Laminated Bamboo with Two Edge Distance Variations <i>Widiya Anistiya K. Rumasoreng, Karyadi and Nindyawati</i>	213
Experimental Study of Shear Strength of Purus Lobang Berkait (PLB): Masonry Wall <i>Marwahyudi, Senot Sangadji, Halwan Alfisa Saifullah and Stefanus Adi Kristiawan</i>	220
Engineering Education: Measuring the Relationship between Knowledge and Confidence to the Student Performance <i>Noek Sulandari, Cindrawaty Lesmana and Cindy Maria Setyana</i>	227
Bio-cord as an Ecotechnological Wastewater Treatment for Productive and Attractive Urban Open Spaces <i>Ferlina Sugata, Nathalia Yunita Sugiharto, Nina Nurviana, Seriwati Ginting, Isabella Ishipraya Andreas, Shirly Nathania Suhanjoyo, Andi A. Hamzah and Heddy Heryadi</i>	233
Relationship between Low Birth Weight (LBW), Birth Length, and Basic Immunization History with Stunting in Children Age 9 - 60 Months in Kabupaten Purwakarta <i>July Ivone, Stella T. Hasianna, Victor Yohanes S. and Vilia Ruthy W.</i>	245
Application of Freeze-thaw Harvest for SARS-CoV-2 PCR EQA Panel Material <i>Nur Ika Hariastuti, Nike Susanti, Hana Apsari Pawestri and Kartika Dewi Puspa</i>	250
Suicide and Narcissistic Personality Traits: A Review of Emerging Studies <i>Charissa Lazarus and Khamelia Malik</i>	254
Expected Attributes to Design Sleeping Facilities for the Elderly based on the Potential Stakeholders Point of View <i>Ely Sarvia, Elizabeth Wianto, Erwin Ardianto Halim and Elvira Natalia</i>	265
Wharton's Jelly Mesenchymal Stem Cells-secretedIDO as Candidate of Anti-inflammation Therapy <i>Wahyu Widowati, Teresa Liliana Wargasetia, Fanny Rahardja, Rimonta F. Gunanegara, Hanna Sari Widya Kusuma, Seila Arumwardana, Cintani Dewi Wahyuni, Cahyaning Riski Wijayanti, Tri Handayani and Rizal Rizal</i>	271
Factors Affecting Success of Team Members in Indonesia Scrum Implementation <i>Apriliana Fajri Wibowo and Yova Ruldeviyani</i>	279
The Application of Digital Module Design of East Sumba Woven Fabric on Interior Accessories <i>Erwin Ardianto Halim, Monica Hartanti, Maresha Caroline Wijanto, Yosepin Sri Ningsih, Hendra Setiawan, Yudita Royandi, Yunita Setyoningrum, Berti Alia Bahaduri and Aulia Wara Arimbi Putri</i>	286

The Use of Technology in Indonesian K-6 Education during Covid-19 Pandemic: A Review <i>Bayu Rima Aditya, Dina Fitria Murad, Oscar Karnalim, Aditya Permadi, Andrisyah, Fathul Jannah and Irawan Nurhas</i>	295
Build Software of Information Management Community Service Events <i>Febrina Anastasha and Teddy Marcus Zakaria</i>	305
User Interactions Analysis on a Moodle-based Online Learning Management System during Pandemic <i>Bernard Renaldy Suteja and Wilfridus Bambang Triadi Handaya</i>	314
Bioactivity of Soybean Tempeh against Diarrhea Associated Pathogen Is More Correlated with the Number of Total Bacteria than Specific Major Bacterial Phylum <i>T. E. Pramudito, E. G. A. Putri, E. Paluphi, G. Florencia, M. R. Gunawan, M. P. Pratiwi and Y. Yogiara</i>	320
Effects of Herbal Ingredients (<i>Allium sativum, Punica granatum, Curcuma longa, Curcuma xanthorrhiza</i>) on FATP3 Gene Expression in Aorta of High Fat Diet-fed Rats: A Preliminary Study <i>Diana Krisanti Jasaputra, Julia Windi Gunadi, Penny Setyawati Martioso, Larissa, Yenny Noor, Irna Permanasari Gani, Erik Dwikurnia Saiman, Desman Situmorang and Andi Haryanto</i>	328
Biochemical Characteristics of Ground Robusta Coffee under Various Postharvest Technologies and Processing Parameters <i>Sri Wulandari, Makhmudun Ainuri and Anggoro Cahyo Sukartiko</i>	333
Substantially Improved Antioxidant Activity of Modified Polymeric Nanostructure Entrapping Curcumin <i>Deni Rahmat, Wahyu Widowati, Etik Mardliyati, Eny Kusrini, Abdi Wira Septama, Yati Sumiyati, Mita Restinia, Sjaikhurrizal El Muttaqien, Cintani Dewi Wahyuni, Hanna Sari Widya Kusuma, Muhammad Aldi, Tri Handayani and Rizal Rizal</i>	344
Breast Cancer Histopathological Image Classification using Progressive Resizing Approach <i>Hendra Bunyamin, Hapnes Toba, Meyliana and Roro Wahyudianingsih</i>	351
Multi-Objective Bees Algorithm for Feature Selection <i>Natalia Hartono</i>	358
Eye Abnormality Automatic Detection using Deep Learning based Model <i>Audyati Gany, Meilan Jimmy Hasugian, Erwani Merry Sartika, Novie Theresia Br. Pasaribu and Hannah Georgina</i>	370
AUTHOR INDEX	377

PAPERS

FULL PAPERS

Design of Bilateral Hand Movement Device using Design Thinking and Quality Function Deployment to Increase the Motoric Function of the Non-Dominant Hand

Novie Theresia Br. Pasaribu¹^a, Vivi Arisandhy²^b, Christina²^c, Elty Sarvia²^d,
Rainisa Maini Heryanto²^e, Erwani Merry Sartika¹^f, Audyati Gany¹^g,
Olga Catherina Pattipawaej³^h, Richard Setiawan¹ⁱ and Jessica²^j

¹Bachelor Program in Electrical Engineering, Universitas Kristen Maranatha, Bandung, Indonesia

²Bachelor Program in Industrial Engineering, Universitas Kristen Maranatha, Bandung, Indonesia

³Bachelor Program in Civil Engineering, Universitas Kristen Maranatha, Bandung, Indonesia

novie.theresia@eng.maranatha.edu, vivi.arisandhy@eng.maranatha.edu, christina@eng.maranatha.edu,
elty.sarvia@eng.maranatha.edu, rainisa.mh@eng.maranatha.edu, erwani.ms@eng.maranatha.edu,
audyati.gany@eng.maranatha.edu, olga.pattipawaej@eng.maranatha.edu, 1722029@eng.maranatha.edu,
1723071@eng.maranatha.edu

Keywords: Bilateral Movement, Design Thinking, Quality Function Deployment.

Abstract: Maintaining the balance of the body to prevent falls and injury can be done by doing one of the physical activities to train arm muscle strength. Bilateral movement exercise will get better results comparing to unilateral movement in increasing muscle strength. This research used Design Thinking, which consisted of empathize, define, ideate, prototype, and test. On the empathize stage, the customer needs were identified by doing the interview and observation. On the define and ideate stage, Quality Function Deployment was used to deploy the customer needs into technical requirements in the Product Planning Matrix and critical part requirements in Part Planning Matrix to make the detailed design. The prototype stage was realized by 3D Modelling. In Part Planning Matrix, there were top 2 contribution values: notice and Virtual Reality (VR). This research had an outcome of a device design that had the aim to increase the motoric function of the non-dominant hand, combined with VR to make it fun while doing the exercise. Future research might include vibration alert in doing the exercise, water flow to burden the rower, to make the exercise more real, continue the QFD with Process Planning Matrix and Production Planning Matrix.

1 INTRODUCTION

The covid-19 pandemic situation has made many changes in daily human life, including the change of physical activities (Rossa, 2020). The pandemic affected humans not doing physical activities globally in the late few months. Doing physical activities

while at home can help our bodies to keep active and prevent diseases. Physical activities help the elderly to maintain the balance of the body to prevent falls and injury (Ramadhani, 2020).

One of those activities is for arm muscle strength. Arm muscle strength exercise does not just train endurance but also increases the muscles' mass.

^a  <https://orcid.org/0000-0001-7774-9675>

^b  <https://orcid.org/0000-0001-9927-472X>

^c  <https://orcid.org/0000-0001-8033-5772>

^d  <https://orcid.org/0000-0003-3708-8723>

^e  <https://orcid.org/0000-0003-0808-538X>

^f  <https://orcid.org/0000-0003-3720-3584>

^g  <https://orcid.org/0000-0002-7389-6667>

^h  <https://orcid.org/0000-0002-7475-1726>

ⁱ  <https://orcid.org/0000-0002-3857-9770>

^j  <https://orcid.org/0000-0002-9014-0167>

Muscles are part of the body that must be trained so the body can be moved well. If the muscles are less trained, there is a possibility to cause pain when doing a hard activity.

According to research, Range of Motion (ROM) exercises affected the increase of muscle power and functional ability (Astrid et al., 2011). The focus of the exercise to some weak parts of the body (unilateral exercise) and the exercise that was for both sides of the body (bilateral exercise) could increase the muscles power, but bilateral exercise could give better outcome compared to unilateral exercise (Cahyati et al., 2013).

Bilateral movement is when both limbs are used in unison to contract the muscles, which creates force and subsequently moves a given load (Fountaine, 2018). People would have a dominant hand that is used to do any activity, however, the motoric function of the non-dominant hand should be concerned to increase its productivity. Besides, the motoric function of the dominant hand could improve the motoric function of the non-dominant hand.

One of the physical activities that use hands to control is rowing. Rowing activity needs both hands to move simultaneously. Rowing simulation could be a choice to increase the motoric function of the non-dominant hand because the player was placed as a rower that rowed the paddles on each hand. The device was designed using rowing simulation movement. This research aim is to design a bilateral hand movement device for exercise program standard for both hands to increase the motoric function of the non-dominant hand.

2 METHODS

The design method that was used in this research was the Design Thinking Method that prioritized the human center approach. There were five stages are empathize, define, ideate, prototype, and test (Sándorová et al., 2020). The flowchart of the Methodology can be seen in Figure 1.

Empathize stage identified the customer needs and did the interview method and observation. The customer's age range was between 19-65 years old.

The next step was the define stage, which would do the problem interpretation so the things to be developed could be determined on the next stage.

The ideate stage was to determine the design idea by using many kinds of techniques and methods. At this stage, Quality Function Deployment (QFD) was used. QFD is typically used as a design tool. It could be used any time when customer needs have to be

identified to determine technical requirements to determine priorities and setting targets (Erdil & Arani, 2019).

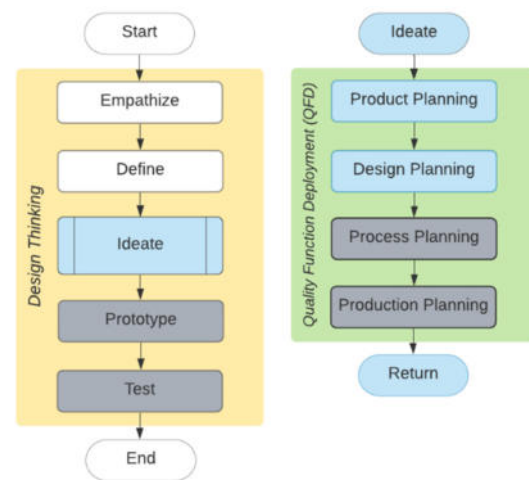

Figure 1: Flowchart of the Methodology.

There were 4 stages in the QFD, which were the Product Planning Matrix, Design Planning Matrix, Process Planning Matrix, and Production Planning Matrix. It was limited only to the Product Planning Matrix and Design Planning Matrix in this research because the goal of this research was to build the design ideas. The Product Planning Matrix, the customer needs, technical requirements, relationships, target values, and contribution values were needed. Based on the technical requirements of the Product Planning Matrix, it was determined the Critical Part Requirements and their Part Specifications and also the contribution values.

In making the design ideas, the anthropometric data would be used as the base to determine the exercise device measurement. Anthropometric data are essential for applying ergonomic principles to the design and improvement of a wide range of products for different users (Dianat et al., 2018). Anthropometric data are used for the proper design of a workstation, equipment, furniture, and so on to decrease awkward postures and stresses on the human body due to improper design (Jalil Mirmohammadi et al., 2006).

The anthropometric data that was used was the Indonesian community anthropometric data as the interpolation result of the British and Hongkong community to the Indonesian community (Nurmianto, 2004). For the body dimension that was not included in the anthropometric data, the anthropometric data in Chuan, et. al's research was used (Chuan et al., 2010).

After the ideate stage was done, the next stage was the prototype, based on those ideas. At this stage, the prototype was built in the 3D Modelling form using Blender Software.

The final stage of Design Thinking was the test, in which testing would be done on the prototype design. But this stage would not be done but would be suggested for future research.

3 RESULTS AND DISCUSSION

The first stage of the Design Thinking Method was empathize, which would identify the customer needs in doing the exercise program. The methods that were used were interviews and observation. Customer needs that were gathered were:

- Because of the Covid-19 pandemic, the customer did not want to do sports activities in public places such as fitness centers or together with others in their community.
- The customer did not want to go out too often.
- The exercise that would be done was low impact.
- The exercise that would be done was fun.
- The exercise that would be done, using both hands.
- The customer could do exercise without other people's help.

The second stage is define. The goal of this stage was to interpret the problems so the things that would be developed could be determined for the next stage. The problems were:

- The exercise device can be used with both hands.
- The exercise device is easy to be used.
- The exercise device can be used without other people's help.
- The exercise device is fun to be used.

The next stage is ideate. The goal of this stage was to determine the exercise device design ideas. Quality Function Deployment method was used, but limited only to Product Planning Matrix and Design Planning matrix.

The Product Planning Matrix can be seen in Figure 2. The customer needs were gained from the problems above, while the importance to the customer was assumed to have the same value for each variable. Relationship symbols were put to see the relationship between the customer needs and the technical requirements. The relationship symbols can be seen in Table 1 (Astuti et al., 2020).

Table 1: Relationship symbols.

Symbol	Definition	Value
●	Strong relationship	9
○	Moderate relationship	3
△	Weak relationship	1
No symbol	No relationship	0

At this stage, the technical requirements that had the 2 highest contribution values were the understanding rate to use and the independence rate of the user.

Technical requirements that had been determined including their contribution values were then transferred to the Part Planning Matrix. Part Planning Matrix can be seen in Figure 3.

In this Part Planning Matrix, critical part requirements were determined, which were the function detail to answer the technical requirement. Critical part requirements are divided into 4 categories, are additional, movement standard, an exercise device, fun facility. Critical part requirements needed the detailed design of its part, and anthropometric data was used to answer some of the technical requirements in this matrix.

Anthropometric data that were used are body dimensions for standing height, elbow height, elbow span, handbreadth, maximum grip diameter, and elbow-fingertip length. Body dimensions for exercise device design can be seen in Table 2:

Technical Requirement	An Exercise Program		Understanding Rate to Use	Independence Rate of the User	Fun Exercise	Importance to the Customer
	Coordinating movement on two arms and hands	Hand Rhythmic Movement				
Customer Requirement						
Exercise tool can be used with both hands	●	●				0.25
Exercise tool is easy to be used			●	○		0.25
Exercise tool can be used without other people's help			○	●		0.25
Exercise tool is fun to be used					●	0.25
Contribution Scale	2.25	2.25	3	3	2.25	
Priority	3	4	1	2	5	
Operational goals/target	Bilateral Movement Exercise	Bilateral Movement Standard	95%	100%	Exercise Provided in a Game	

Symbol	Definition	Value
●	Strong relationship	9
○	Moderate relationship	3
△	Weak relationship	1
No symbol	No relationship	0

Figure 2: Product Planning Matrix.

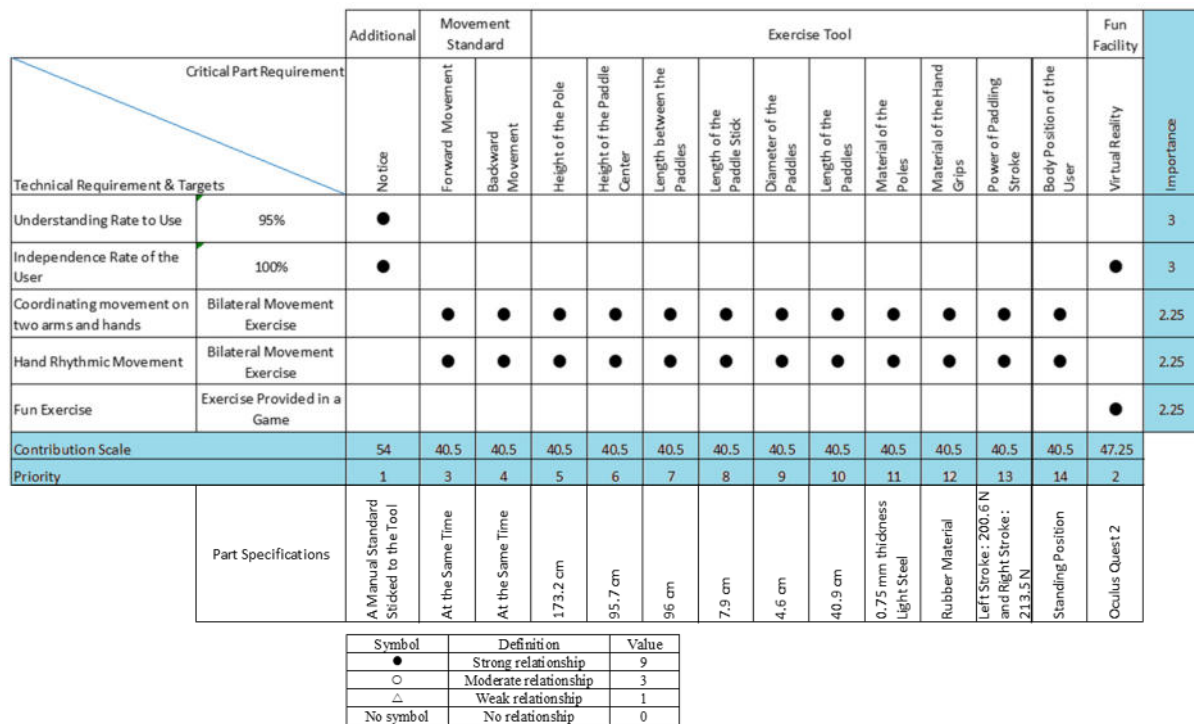

Figure 3: Part Planning Matrix.

Table 2: Body dimensions for exercise device design.

Device dimensions	Body dimensions	Percentile	Gender	Dimensions (cm)
Height of the pole	Standing height	95th	Males	173.2
Height of the paddle center	Elbow height	50th	Females	95.7
Length between the paddles	Elbow span	95th	Males	96
Length of the paddles sticks	Handbreadth	50th	Males	7.9
Diameter of the paddles	Maximum grip diameter	50th	Females	4.6
Length of the paddles	Elbow-fingertip length	50th	Females	40.9

- Height of the pole using the standing height body dimension with 95th percentile for males, which is 173.2 cm. The aim of using the 95th percentile for males was the flexible use of the device for tall users.
 - Height of the paddle center using elbow height body dimension with 50th percentile for females, which is 95.7 cm. The aim of using the 50th percentile for females was the suitability of the height of the paddle center measurement and the average body dimension for males and females.
 - Length between the paddles using elbow span body dimension with the 95th percentile for males which was 96 cm. The aim of using the 95th percentile for males was the flexible use of the device for big users.
 - Length of the paddles sticks using handbreadth body dimension with the 50th percentile for males which was 7.9 cm. The aim of using the 50th percentile was the suitability of the length of the paddles stick and the average body dimension for males and females.
 - Diameter of the paddles using maximum grip diameter with the 50th percentile for females which was 4.6 cm. The aim of using the 50th percentile was the suitability of the diameter of the paddles and the average body dimension for males and females.
 - Length of the paddles using elbow-fingertip length body dimension with the 50th percentile for females which was 40.9 cm. The aim of using the 50th percentile for females was the suitability of the length of the paddles and the average body dimension for males and females.
- Part Planning Matrix also had the same principles, as the Product Planning Matrix. At this stage, the critical part requirements that had the 2 highest

contribution values were notice and Virtual Reality. By using all of the data from Part Planning Matrix, such as anthropometric data and its additional idea such as putting the notice and using the Virtual Reality, the design of the device was completed.

Virtual Reality (VR) was the simulation of the real world or the imaginative environment, could be felt in three dimensions, and also gave the visual interactive experience in the real-time movement with voice or any other feedback (Okechukwu & Udoka, 2011). VR has incorporated playing a game using a system capable of sensing movement (e.g., Xbox Kinect). VR has also been combined with traditional exercise tasks, such as stationary cycling treadmill running, and ergometer rowing (Murray et al., 2016). VR can be used as additional supporting tools as controller/joystick that enables the users to do variety movement, such as grabbing and throwing. These movements can help the motoric performance increasing process on the non-dominant hand.

The next step was making the prototype, using the design development with 3D Modelling using Blender Software. The result was shown in Figure 4 for the Front View, Figure 5 for the Top View and Figure 6 for the Side View. In Figure 7, the person's position when the rowing exercise is conducted, it is done using Bilateral Hand Movement Device.

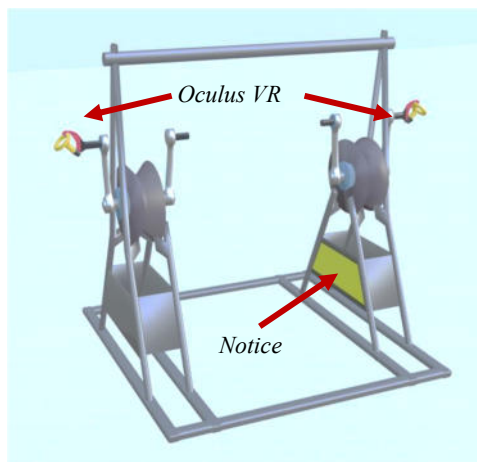

Figure 4: Design of Bilateral Hand Movement Device (Front View).

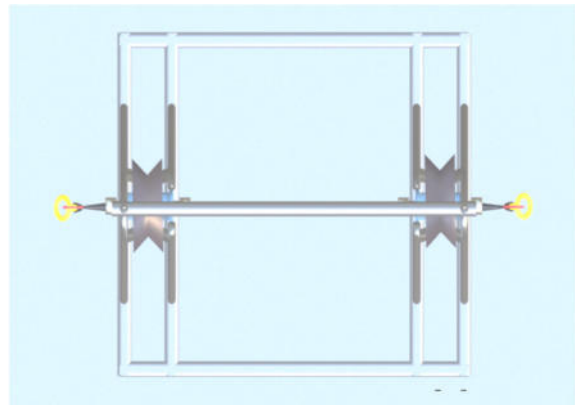

Figure 5: Design of Bilateral Hand Movement Device (Top View).

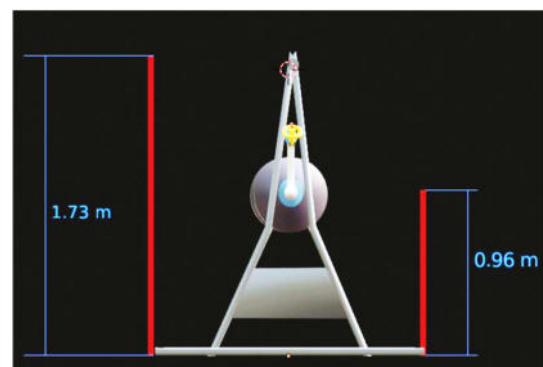

Figure 6: Design of Bilateral Hand Movement Device (Side View).

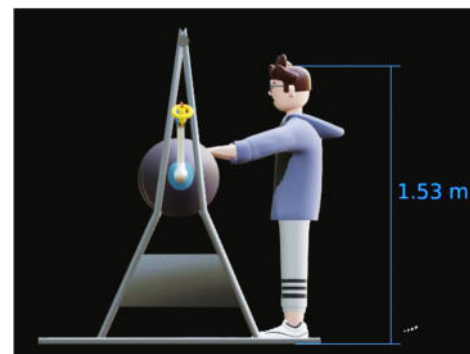

Figure 7: The Person's position while doing the rowing exercise.

The VR would be used while the person was doing the exercise using the device. The VR would be completed with the fun game as if the person was doing the rowing.

4 CONCLUSIONS

This research had an outcome of a design of a bilateral hand movement device that had the aim to increase the motoric function of the non-dominant hand. The device is combined with VR to make it fun while doing the exercise. The person who was doing the exercise would feel as if he was doing the real rowing, according to the game on the VR. It was related to previous researches that mentioned the use of VR was combined with traditional exercise tasks, such as stationary cycling treadmill running, and ergometer rowing, and related also to the exercise of bilateral movement. The device can be seen in Figure 4 to Figure 7.

In the Part Planning matrix, the critical part requirements that had the 2 highest contribution values were notice and Virtual Reality. Future research might include the vibration alert in doing the exercise, the water flow to burden the rower, to make the exercise more real. This research was early research of integrating the device with VR. For future research, it might continue the QFD with Process Planning Matrix and Production Planning Matrix. Other future research ideas are the material test to determine which material would be fit for the exercise tool, and the rowing game software that would integrate hardware, software, and experiment.

ACKNOWLEDGEMENTS

The authors would like to say thanks to Universitas Kristen Maranatha that has given fund research, and to all the respondents that were interviewed.

REFERENCES

- Astrid, M., Elly, N., & Budiharto. (2011). Pengaruh Latihan Range of Motion (ROM) terhadap Kekuatan Otot, Luas Gerak Sendi dan Kemampuan Fungsional Pasien Stroke di RS Sint Carolus Jakarta. In *Jurnal Ilmu Keperawatan dan Kebidanan: Vol. 1(4)* (pp. 175–182).
- Astuti, R., Thessalona, I., & Setiyawan, D. T. (2020). The Product Quality Improvement: An Example from a Rice Milling in Indonesia. *IOP Conference Series: Earth and Environmental Science*, 515(1). doi:10.1088/1755-1315/515/1/012005
- Cahyati, Y., Nurachmah, E., & Hastono, S. P. (2013). Perbandingan Peningkatan Kekuatan Otot Pasien Hemiparese Melalui Latihan ROM Unilateral dan Bilateral. *Jurnal Keperawatan Indonesia*, 16(1), 40–46. doi:10.7454/jki.v16i1.18
- Chuan, T. K., Hartono, M., & Kumar, N. (2010). Anthropometry of the Singaporean and Indonesian populations. *International Journal of Industrial Ergonomics*, 40(6), 757–766. doi:10.1016/j.ergon.2010.05.001
- Dianat, I., Molenbroek, J., & Castellucci, H. I. (2018). A review of the methodology and applications of anthropometry in ergonomics and product design. *Ergonomics*, 61(12), 1696–1720. doi:10.1080/00140139.2018.1502817
- Erdil, N. O., & Arani, O. M. (2019). Quality function deployment: more than a design tool. *International Journal of Quality and Service Sciences*, 11(2), 142–166. doi:10.1108/IJQSS-02-2018-0008
- Fountaine, C. J. (2018). Unilateral and Bilateral Exercise Movements: Considerations for Program Design. *ACSM'S Health & Fitness Journal*, 22(3), 11–16. doi:10.1249/FIT.0000000000000390
- Jalil Mirmohammadi, S., Houshang Mehrparvar, A., Jafari, S., & Mostaghaci, M. (2006). An Assessment of the Anthropometric Data of Iranian University Students. *International Journal of Occupational Hygiene*, 3(2), 85–89. <http://ijoh.tums.ac.ir>
- Murray, E. G., Neumann, D. L., Moffitt, R. L., & Thomas, P. R. (2016). The effects of the presence of others during a rowing exercise in a virtual reality environment. *Psychology of Sport and Exercise*, 22, 328–336. doi:10.1016/j.psychsport.2015.09.007
- Nurmianto, E. (2004). *Ergonomi: Konsep Dasar dan Aplikasinya* (2nd ed.). Penerbit Guna Widya, Surabaya, Indonesia.
- Okechukwu, M., & Udoka, F. (2011). Understanding Virtual Reality Technology: Advances and Applications. *Advances in Computer Science and Engineering, March*. doi:10.5772/15529
- Ramadhani, C. (2020). *Manfaat Aktivitas Fisik di Masa Pandemi Covid-19*. <https://www.beritasatu.com/kesehatan/628363/manfaat-aktivitas-fisik-di-masa-pandemi-covid19>
- Rossa, V. (2020). *Terjadi Perubahan Aktivitas Fisik Selama Pandemi Covid-19, Apa Saja?* <https://www.suara.com/health/2020/06/17/120231/terjadi-perubahan-aktivitas-fisik-selama-pandemi-covid-19-apa-saja?page=all>
- Sándorová, Z., Repáňová, T., Palenčíková, Z., & Beták, N. (2020). Design thinking - A revolutionary new approach in tourism education? *Journal of Hospitality, Leisure, Sport and Tourism Education*, 26, 100238. doi:10.1016/j.jhlste.2019.100238